

## Gagliardetti

Pennant  
Fanion  
Wimpel

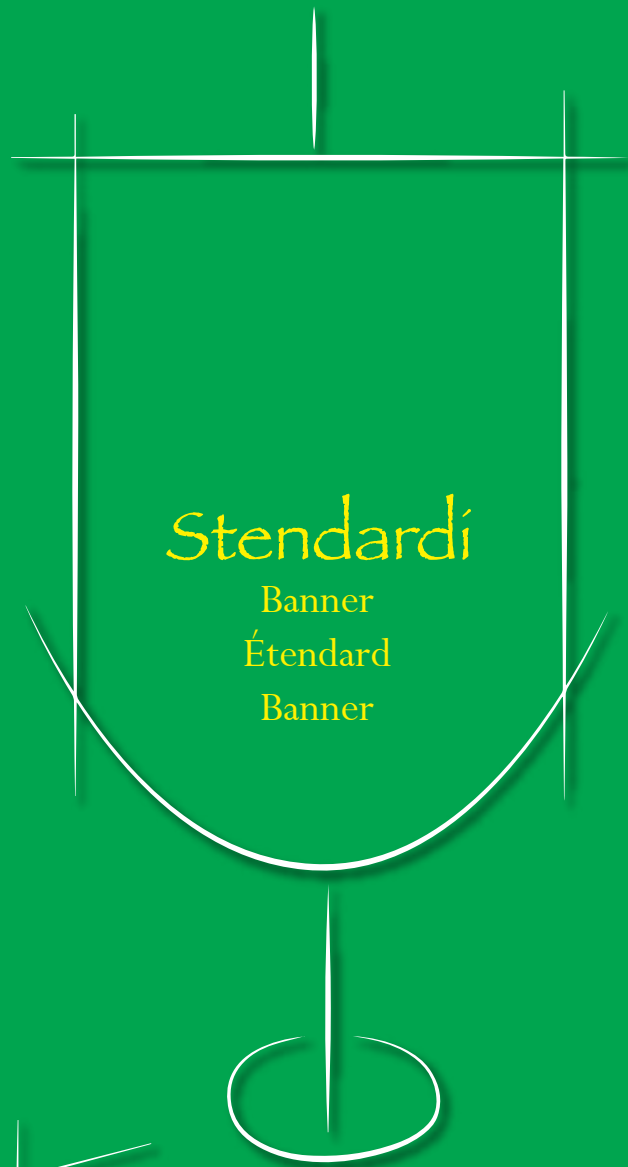

## Stendardi

Banner  
Étendard  
Banner

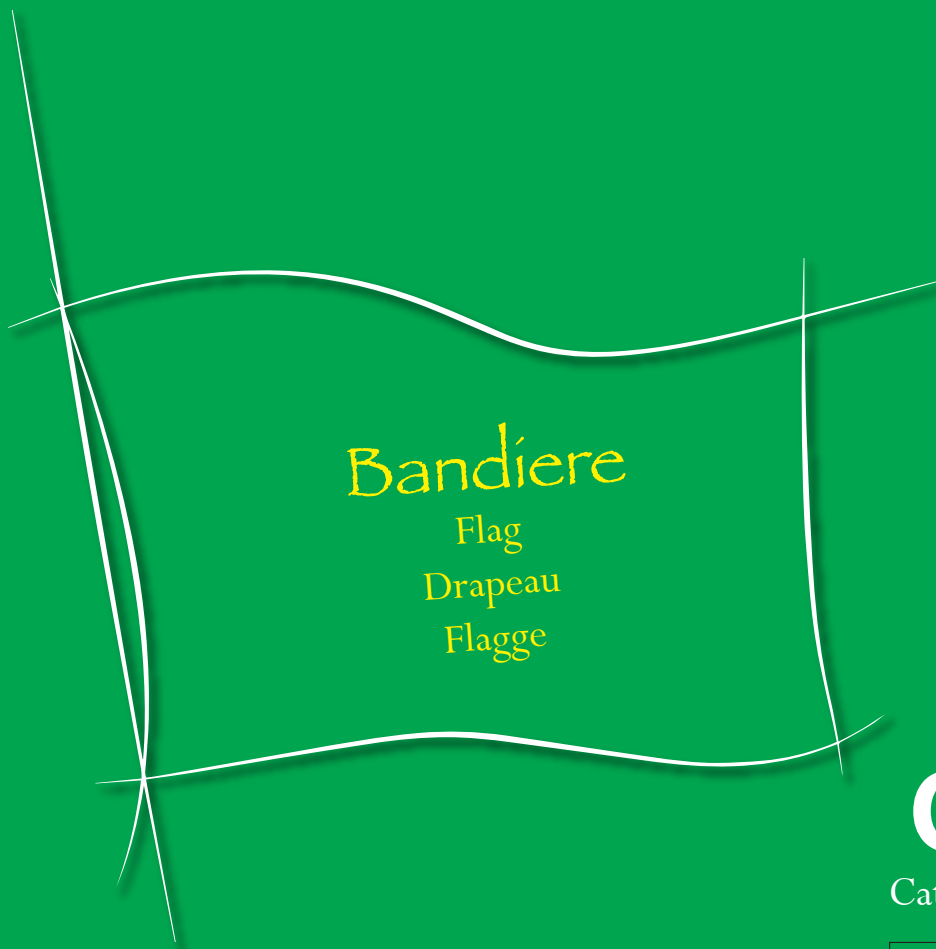

## Bandiere

Flag  
Drapeau  
Flagge

# CATALOGO

Catalog / Catalogue / Katalog

MADE IN ITALY

# IL GAGLIARDETTO ..... pag. 2-66

The Pennant  
Le Fanion  
Den Wimpel

- **Indice modelli** ..... pag. 4-11  
Models' Index  
Index des modèles  
Index-Modelle
- **Modelli** ..... pag. 12-62  
Models  
Modèles  
Modelle
- **Rifiniture ed Accessori** ..... pag. 63-66  
Finishing stages and Accessories  
Finitions et accessoires  
Oberflächen und Zubehör

# Lo STENDARDO ..... pag. 67-73

The Banner  
La Bannière  
Das Banner

# La BANDIERA ..... pag. 74-77

The Flag  
Le Drapeau  
Das Flag

MADE IN ITALY

- **Guida alla scelta del modello** ... pag. 3  
Models' Selection Guide  
Guide de sélection des modèles  
Wie Sie das Modell wählen
- **Indice modelli gagliardetti** ..... pag. 4-11  
Models' Index  
Index des modèles  
Index-Modelle
- **Modelli TRIANGOLARI** ..... pag. 12-20  
TRIANGULAR models  
modèles TRIANGULAIRES  
Models TRIANGULAR
- **Modelli PENTAGONALI** ..... pag. 21-35  
PENTAGONAL models  
modèles PENTAGONAUX  
Models FÜNFECK
- **Modelli RETTANGOLARI** ..... pag. 36-45  
RECTANGULAR models  
modèles RECTANGULAIRES  
Models RECTANGULAR
- **Modelli a SCUDO** ..... pag. 46-53  
SHIELD models  
modèles BOUCLIER  
Models zu SHIELD
- **Modelli SPECIALI** ..... pag. 54-62  
SPECIAL models  
modèles SPÉCIAUX  
Models SPECIAL
- **Rifiniture** ..... pag. 63  
Finishings  
Finitions  
Bearbeitungen
- **Accessori** ..... pag. 64-65-66  
Accessories  
Accessoires  
Zubehör

# IL GAGLIARDETTO

THE LE DEN  
PENNANT FANION WIMPEL

**“ Il gagliardetto non è un semplice pezzo di stoffa; il gagliardetto è un'anima, il gagliardetto è un ideale. ”**

*“The pennant is not a simple piece of fabric; the pennant is a spirit, the pennant is an ideal.”*

*“Le fanion n'est pas un simple morceau de tissu ; le fanion est une âme, le fanion est un idéal.”*

*“Ist er das Gagliardetto kein einfacher Teil von dem Stoff; das Wimpel ist sie eine Seele, das Gagliardetto ist ein Ideal.”*



# GUIDA alla scelta del modello.

## 1) SCEGLI LA FORMA e IL MODELLO sfogliando l'indice da pag. 4 a pag.11.

CHOOSE THE MODEL and the SHAPE BY FLIPPING the index from page 4 to 11.

CHOISISSEZ LA FORME ET LE MODÈLE en parcourant l'index de la page 4 à la page 11.

WÄHLEN SIE DAS MODELL UND DIE FORM der Index-Seite 4 auf Seite 11.

## 2) VISIONA LA PAGINA TECNICA dedicata al modello scelto.

LOOK AT THE TECHNICAL PAGE dedicated to the model chosen.

ALLEZ A LA PAGE TECHNIQUE du modèle en question.

SCHAUEN SIE TECHNISCHE SEITEN den gewählten Modell gewidmet.

\* se il modello base rappresentato non è quello che stai cercando prova a vedere quali sono le varianti disponibili: le indicazioni le trovi a fondo pagina.

If the basic model represented is not what you are looking for, try to see which are the available variants : indications are at the bottom of the page.

Si le modèle de base représenté n'est pas celui que vous recherchez, essayez de voir quelles sont les versions disponibles: les indications sont au bas de la page.

Wenn dargestellte Basismodell, ist nicht versuchen, sehen sie die bverfugbaren Varianten: die Angaben sind die Zeichen sind am unteren Rand der Seite.

## 3) SCEGLI IL COLORE di frangia/passamaneria/fiocco/cordino e borchia a pag.63/64

CHOOSE fringe / trimmings / tassel / rope and stud COLOR at page 63/64.

CHOISISSEZ LA COULEUR de la frange / la passementerie / le pompon / le cordon et le clou à la page 63/64.

WÄHLEN SIE DIE FARBE Fransen / Posament / Bausch / Metallverzierung auf Seite 63/64.

## 4) SCEGLI LA TIPOLOGIA DI PERSONALIZZAZIONE tra quelle qui sotto presentate.

CHOOSE THE TYPE OF CUSTOMIZATION among those presented below.

CHOISISSEZ LE TYPE DE PERSONNALISATION parmi celles qui sont présentées ci-dessous.

WÄHLEN SIE DIE TYPOLOGIE DER PERSONALISIERUNG unter den nachstehend vorgestellt.

**DIGITALE**  
su raso Eco  
(raso con supporto  
cartaceo nel retro)

DIGITAL  
on cheap satin  
(Satin paper in the  
back)

NUMERIQUE  
sur satin économique  
(papier satiné au verso)

DIGITAL  
auf Wirtschafts Satin  
(Satin Papier auf  
der Rückseite)



**DIGITALE**  
su raso di  
acetato

DIGITAL  
on satin acetate

NUMERIQUE  
sur acetate

DIGITAL  
auf Satin Acetat



**RICAMO**  
su raso turco

EMBROIDERY  
on turkish satin

BRODERIE  
sur satin turc

STICKEREI  
auf Satin türkische



**NEUTRO**  
raso di  
poliestere

NEUTRAL  
on polyester satin

NEUTRE  
sur satin de polyester

NEUTRAL  
auf Satin Polyester



# MODELLI TRIANGOLARI

N.B: Le misure sono comprensive di frangia (ove prevista)

## TRIANGULAR MODELS

NB: The measures include the fringe (if provided)

## MODÈLES TRIANGULAIRES

NB: Les mesures incluent la frange (si fournie)

## TRIANGULAR MODELLE

NB: Die Maßnahmen sind inklusive Fransen (Wenn verfügbar)



**MOD.3**  
(cm 14x17)  
- pag.12 -



**MOD.34**  
(cm 17x18,5)  
- pag.13 -



**MOD.6**  
(cm 23x28,5)  
- pag.14 -



**MOD.19**  
(cm 21,5x33,5)  
- pag.15 -



**MOD.1/f**  
(cm 26,5x34,5 escluso fiocco)  
- pag.16 -

**MOD.1**  
(cm 32x39)  
- pag.17 -

**MOD.20**  
(cm 33,5x40)  
- pag.18 -

**MOD.42**  
(cm 37,5x47)  
- pag.19 -

**N.B: Le misure riportate potrebbero variare di qualche mm. rispetto al prodotto finito.**

N.B: The given measures may vary by a few mm. compared to the finished product.

N.B: Les mesures peuvent varier de quelques mm. par rapport au produit fini.

NB: Die Messungen von einigen mm. aus dem Endprodukt variieren.



# MODELLI PENTAGONALI

N.B: Le misure sono comprensive di frangia e/o passamaneria (ove previste)

## MODELS PENTAGONAL

NB: The measures include the fringe and / or trimming (if provided)

## MODÈLES PENTAGONAUX

NB: Les mesures incluent la frange et / ou la passemanerie (Si fournies)

## MODELLE FÜNF

NB: Die Maßnahmen sind inklusive Fransen und / oder Posement (Wenn verfügbar)

INDICE MODELLI GAGLIARDETTI  
 pennants models' index  
 index modèles fanions  
 Index Modelle Wimpel

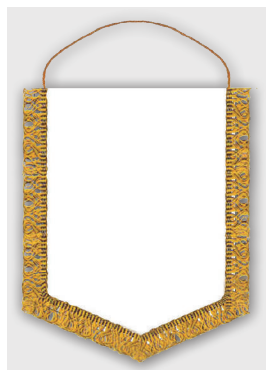

**MOD.12**  
 (cm 11,5x13)  
 - pag.21 -



**MOD.18**  
 (cm 14x14,5)  
 - pag.22 -



**MOD.13**  
 (cm 17,5x21,5)  
 - pag.23 -

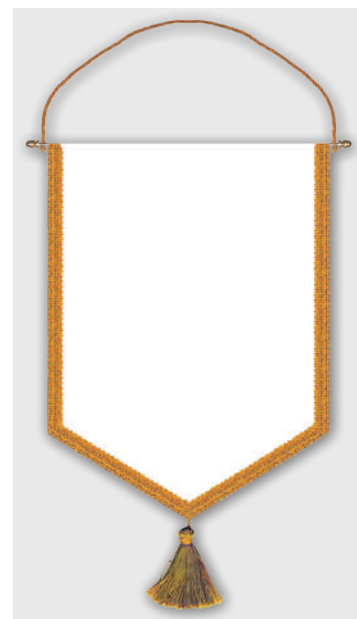

**MOD.16**  
 (cm 18,5x24,5 escluso fiocco)  
 - pag.24 -

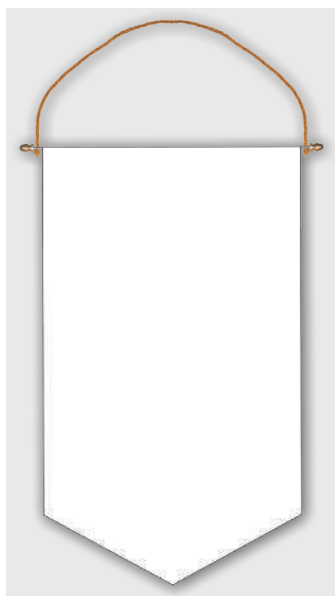

**MOD.17**  
 (cm 16,5x27,5)  
 - pag.25 -

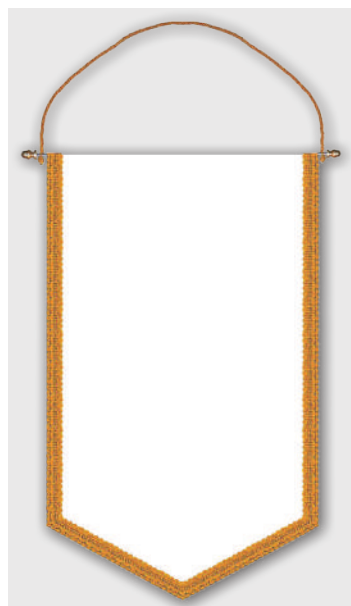

**MOD.14**  
 (cm 16,5x27,5)  
 - pag.26 -



**MOD.43**  
 (cm 18x28,5)  
 - pag.27 -

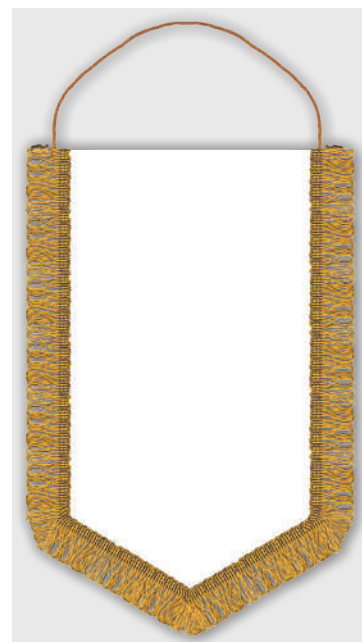

**MOD.5**  
 (cm 21x30)  
 - pag.28 -

**N.B: Le misure riportate potrebbero variare di qualche mm. rispetto al prodotto finito.**

N.B: The given measures may vary by a few mm. compared to the finished product.

N.B: Les mesures peuvent varier de quelques mm. par rapport au produit fini. NB:

Die Messungen von einigen mm. aus dem Endprodukt variieren.

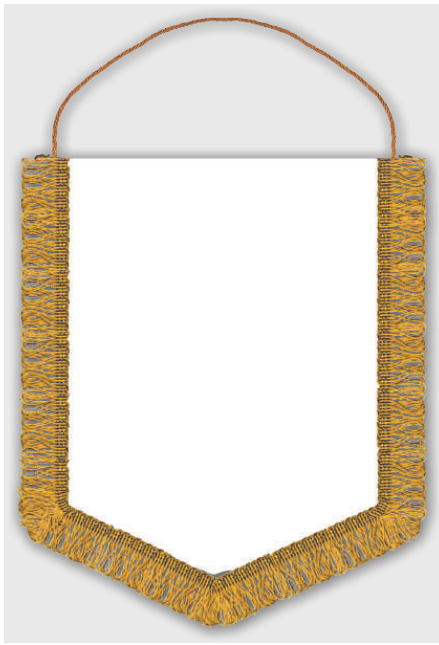

**MOD.15**  
(cm 23,5x27,5)  
- pag.29 -

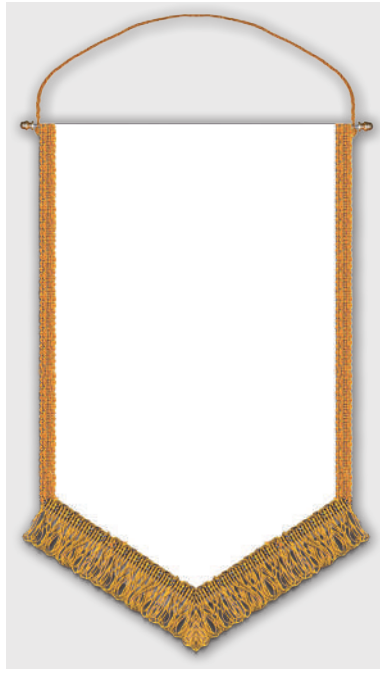

**MOD.31**  
(cm 20,5x30)  
- pag.30 -



**MOD.7**  
(cm 20,5x27,5 escluso fiocco)  
- pag.31 -



**MOD.10**  
(cm 24x31)  
- pag.32 -

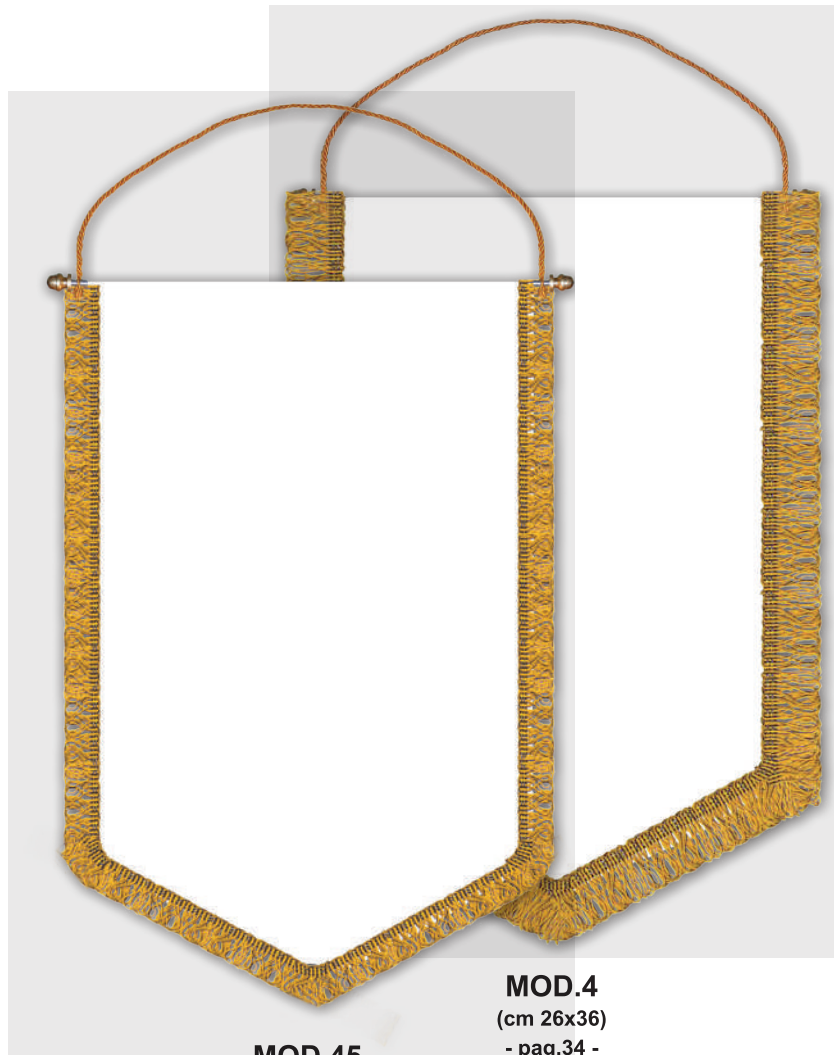

**MOD.45**  
(cm 23x34,5)  
- pag.33 -

**MOD.4**  
(cm 26x36)  
- pag.34 -

**N.B: Le misure riportate potrebbero variare di qualche mm. rispetto al prodotto finito.**

N.B: The given measures may vary by a few mm. compared to the finished product.

N.B: Les mesures peuvent varier de quelques mm. par rapport au produit fini.

NB: Die Messungen von einigen mm. aus dem Endprodukt variieren.



# MODELLI RETTANGOLARI

N.B: Le misure sono comprensive di frangia e/o passamaneria (ove previste)

## MODELS RECTANGULAR

NB: The measures include the fringe and / or trimming (if provided)

## MODÈLES RECTANGULAIRE

NB: Les mesures incluent la frange et / la passanterie (Si fournies)

## MODELLE RECTANGULAR

NB: Die Maßnahmen sind inklusive Fransen und / oder Posement (Wenn verfügbar)

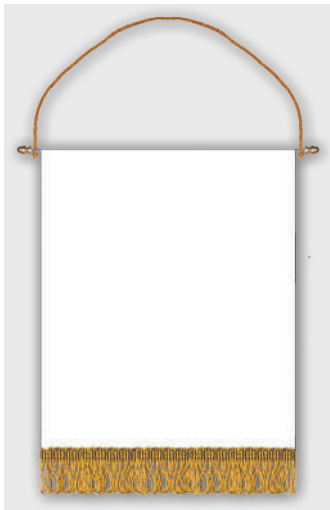

**MOD.24**  
(cm 15,5x21)  
- pag.36 -



**MOD.25**  
(cm 21x19,5)  
- pag.37 -

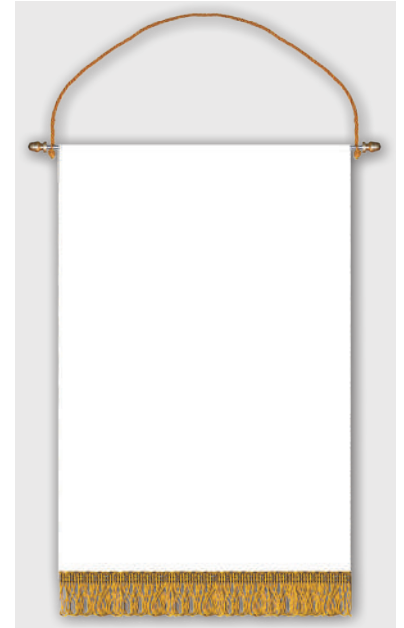

**MOD.26**  
(cm 18x27)  
- pag.38 -

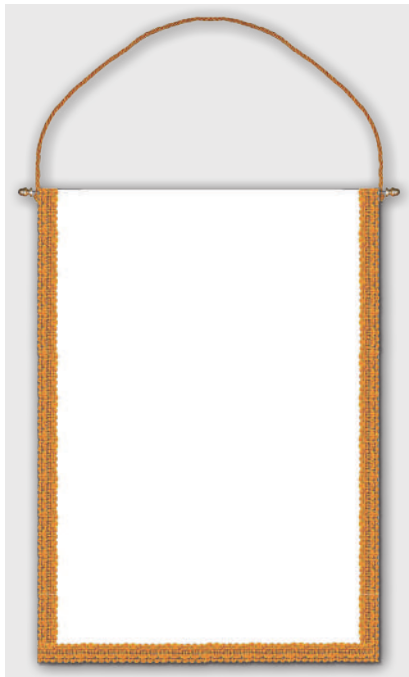

**MOD.32**  
(cm 18,5x25)  
- pag.39 -



**MOD.35**  
(cm 19x25,5)  
- pag.40 -

**N.B: Le misure riportate potrebbero variare di qualche mm. rispetto al prodotto finito.**

N.B: The given measures may vary by a few mm. compared to the finished product.  
N.B: Les mesures peuvent varier de quelques mm. par rapport au produit fini. NB: Die Messungen von einigen mm. aus dem Endprodukt variieren.



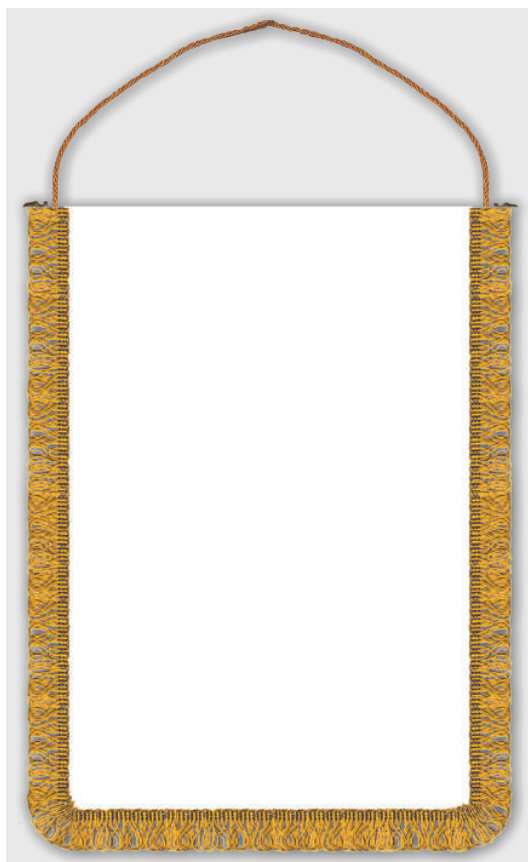

**MOD.29**  
(cm20x29,5)  
- pag.41 -

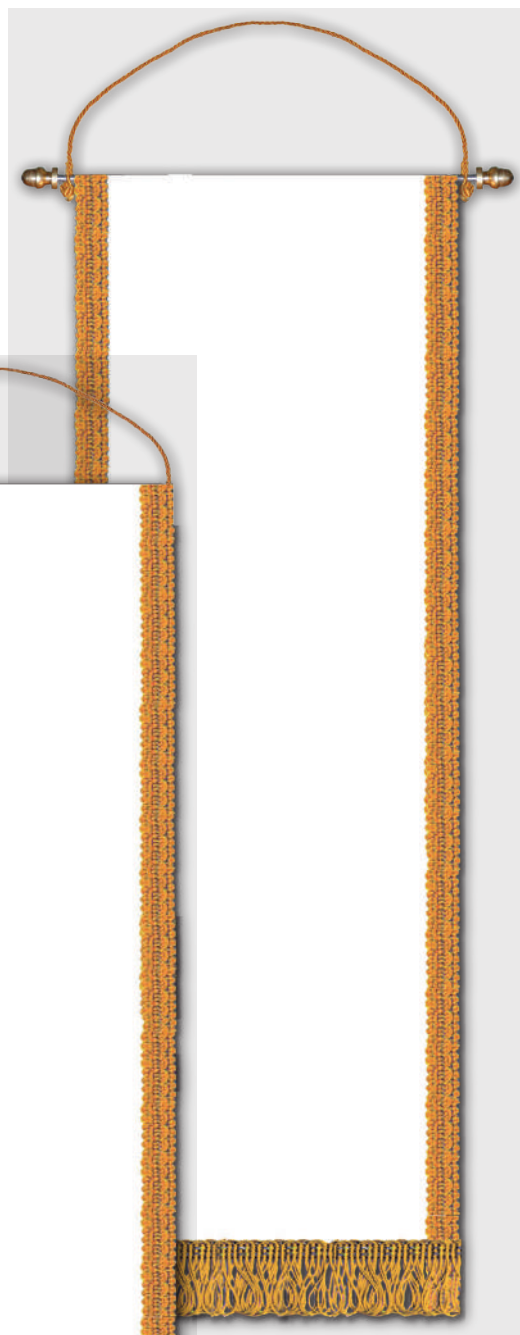

**MOD.39**  
(cm 14x73)  
- pag.44 -

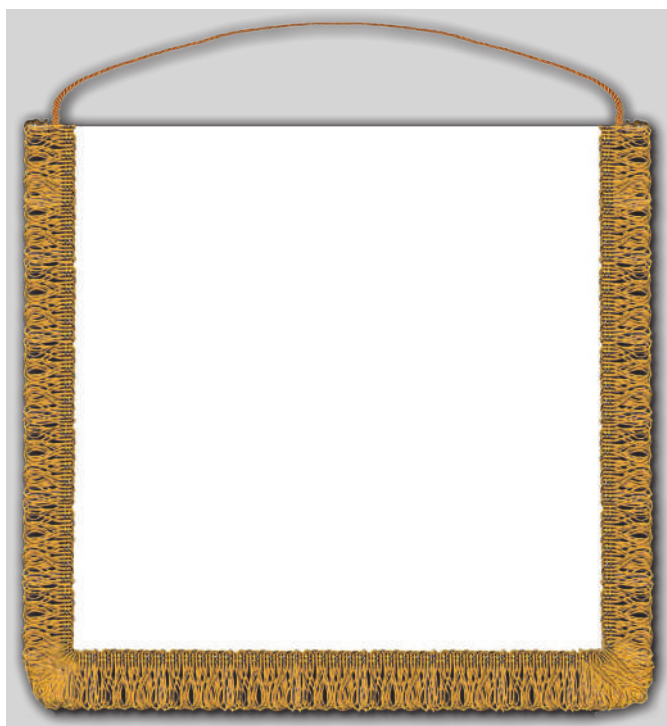

**MOD.36**  
(cm 34x27)  
- pag.42 -

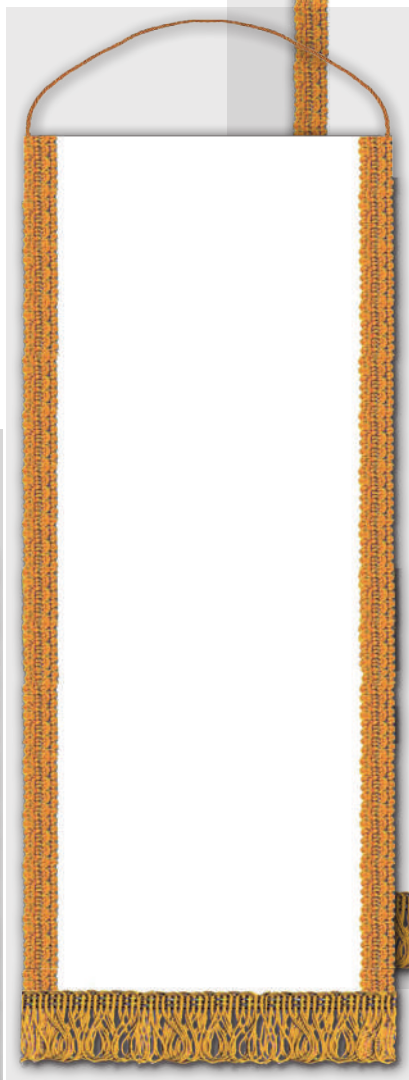

**MOD.38**  
(cm 11x42)  
- pag.43 -

DE IN IT



**N.B: Le misure riportate potrebbero variare di qualche mm. rispetto al prodotto finito.**

N.B: The given measures may vary by a few mm. compared to the finished product.

N.B: Les mesures peuvent varier de quelques mm. par rapport au produit fini.

NB: Die Messungen von einigen mm. aus dem Endprodukt variieren.

## MODELLI A SCUDO

N.B: Le misure sono comprensive di frangia (ove prevista)

### MODELS SHIELD

NB: The measures include the of fringe (if provided)

### MODÈLES BOUCLIERS

NB: Les mesures incluent la frange (si fournie)

### MODELLE SHIELD

NB: Die Maßnahmen sind inklusive Fransen (Wenn verfügbar)



**MOD.22**  
(cm 10,5x14,5)  
- pag.46 -



**MOD.9**  
(cm 13,5x16,5)  
- pag.47 -



**MOD.33**  
(cm 15,5x18,5)  
- pag.48 -



**MOD.23**  
(cm 20,5x28)  
- pag.49 -



**MOD.21**  
(cm 27,5x28,5)  
- pag.50 -



**MOD.2**  
(cm 26,5x34)  
- pag.51 -



**MOD.41**  
(cm 32x43)  
- pag.52 -

**N.B: Le misure riportate potrebbero variare di qualche mm. rispetto al prodotto finito.**

N.B: The given measures may vary by a few mm. compared to the finished product.  
N.B: Les mesures peuvent varier de quelques mm. par rapport au produit fini.  
N.B: Die Messungen von einigen mm. aus dem Endprodukt variieren.

# MODELLI SPECIALI

N.B: Le misure sono comprensive di frangia e/o passamaneria (ove previste)

## MODELS SPECIAL

NB: The measures include the fringe and/or trimming (if provided)

## MODÈLES SPÉCIAUX

NB: Les mesures incluent la frange et/ou la passemanterie (Si fournies)

## MODELLE SPECIAL

NB: Die Maßnahmen sind inklusive Fransen und / oder Posement (Wenn verfügbar)

**INDICE MODELLI GAGLIARDETTI**  
 pennants models' index  
 index modèles fanions  
 Index Modelle Wimpel

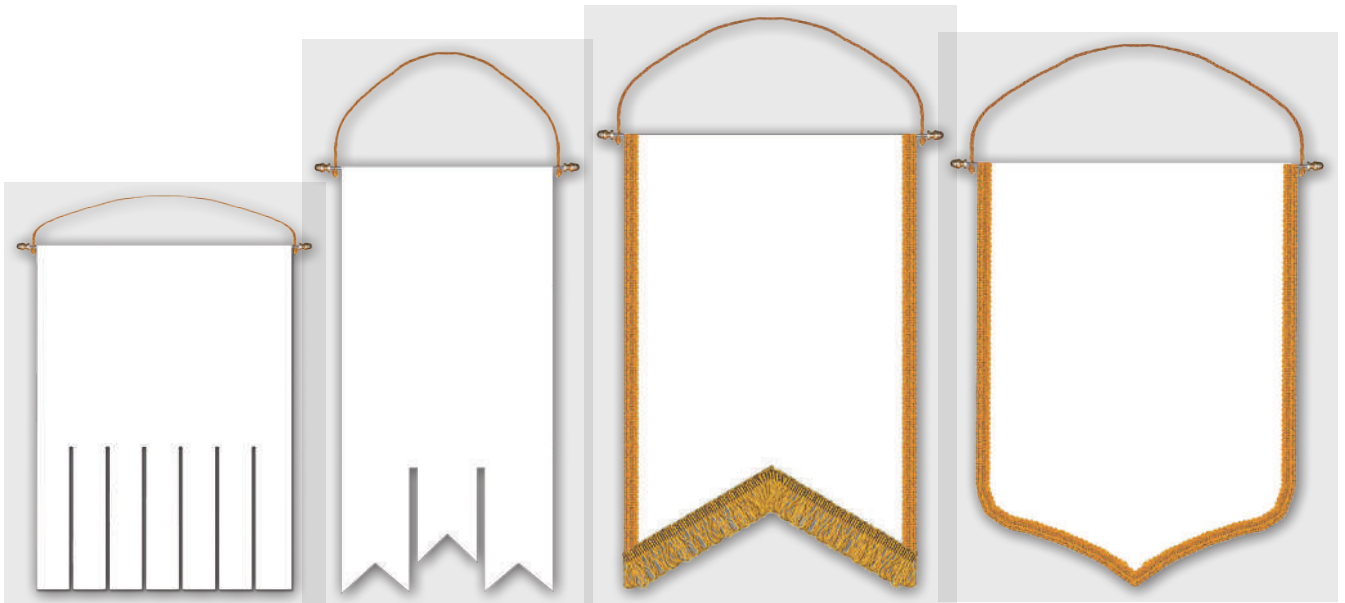

**MOD.37**  
(cm 17,5x24,5)  
- pag.54 -

**MOD.27**  
(cm 15x29,5)  
- pag.55 -

**MOD.30**  
(cm 20x31)  
- pag.56 -

**MOD.28**  
(cm 22x29)  
- pag.57 -

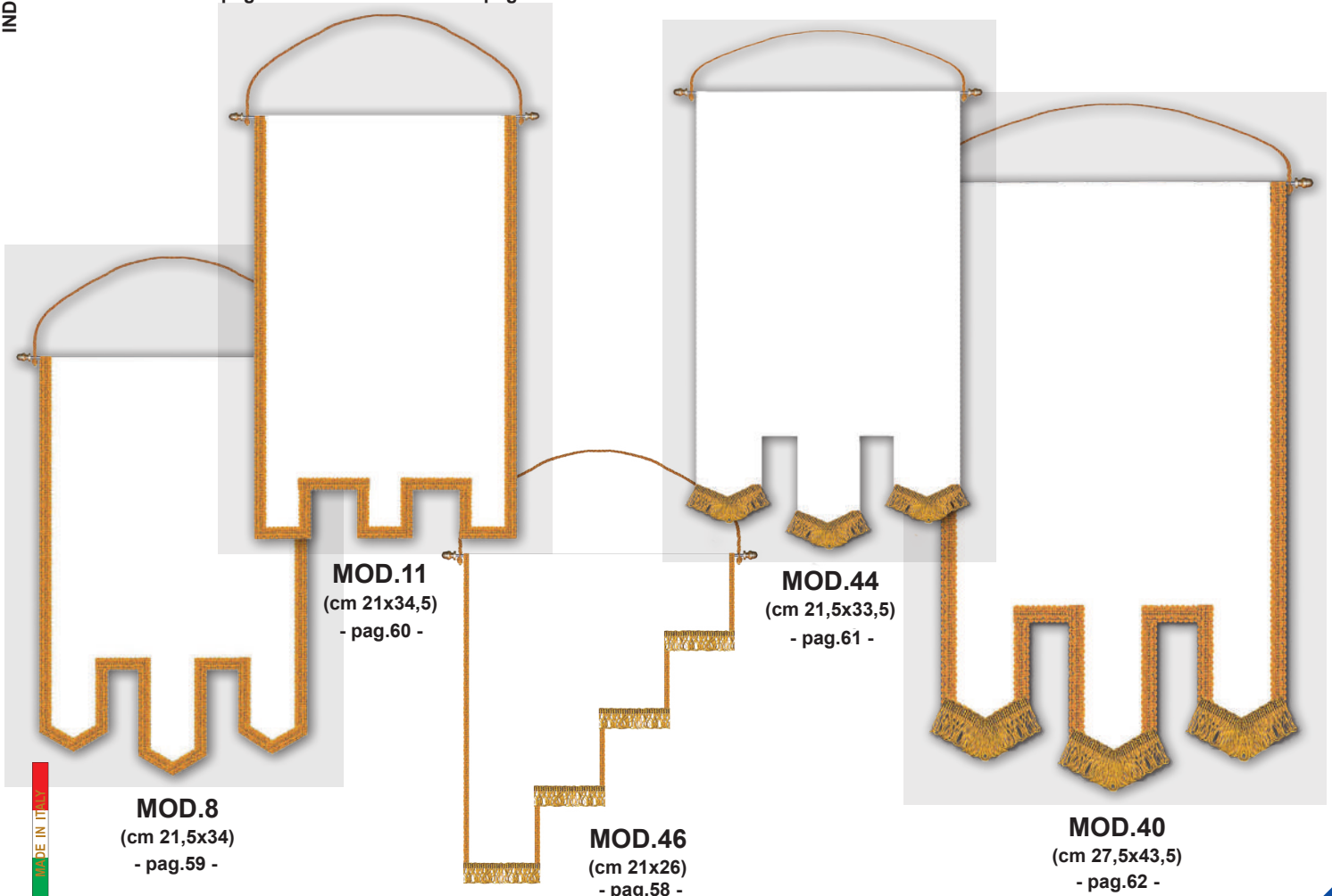

**MOD.8**  
(cm 21,5x34)  
- pag.59 -

**MOD.11**  
(cm 21x34,5)  
- pag.60 -

**MOD.46**  
(cm 21x26)  
- pag.58 -

**MOD.44**  
(cm 21,5x33,5)  
- pag.61 -

**MOD.40**  
(cm 27,5x43,5)  
- pag.62 -

**N.B: Le misure riportate potrebbero variare di qualche mm. rispetto al prodotto finito.**

N.B: The given measures may vary by a few mm. compared to the finished product.

N.B: Les mesures peuvent varier de quelques mm. par rapport au produit fini.

NB: Die Messungen von einigen mm. aus dem Endprodukt variieren.



# VARIANTI CON CORDINO

VERSIONS WITH ROPE

VERSIONS AVEC CORDONS

VERSIONEN MIT SEIL

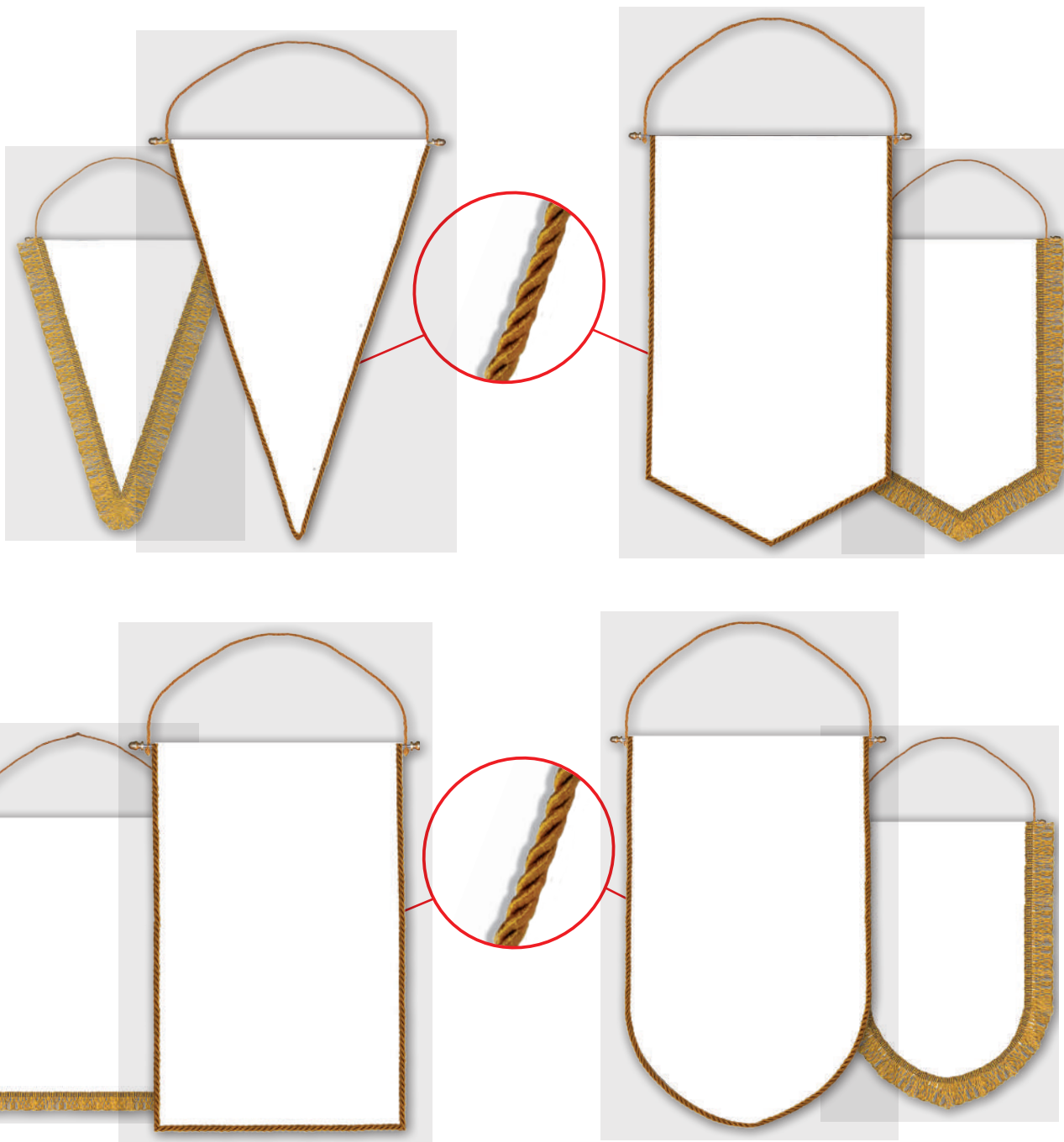

INDICE MODELLI GAGLIARDETTI  
pennants models' index  
index modèles fanions  
Index Modelle Wimpel

**Visualizza la disponibilità di questa variante al fondo della pagina tecnica di ogni modello.**

View the availability of this variant at the bottom of the technical page of each model.

Voir la disponibilité de cette variante au bas de la page technique de chaque modèle.

Informieren Sie sich über die Verfügbarkeit eines Variante mit dem unteren Bogen des jeweiligen Modells.

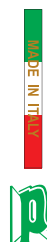

# MODELLO 3

cm 14x17 comprensivo di frangia

## Triangolare con frangia, cordino cucito, busta.

Triangle with sewn rope, fringed, envelope and wand. Triangulaire, avec frange, cordon cousu, pochette. Dreieckig mit Kordel, Fransen Umschlag.

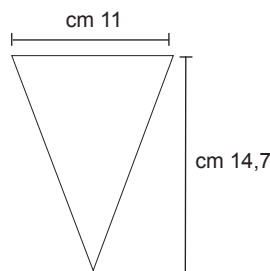

### AREA MASSIMA DI PERSONALIZZAZIONE:

la grafica dovrà essere inserita all'interno dell'area.

MAXIMUM AREA FOR CUSTOMIZATION: graphics should be included inside the lines.

ZONE MAXIMALE DE MARQUAGE: le graphique devra être inséré à l'intérieur de la zone.

HÖCHSTFLÄCHE DER PERSONALISIERUNG: die grafiken sollten die Grafik sollte.

GAGLIARDETTI  
pennant  
fanion  
wimpel

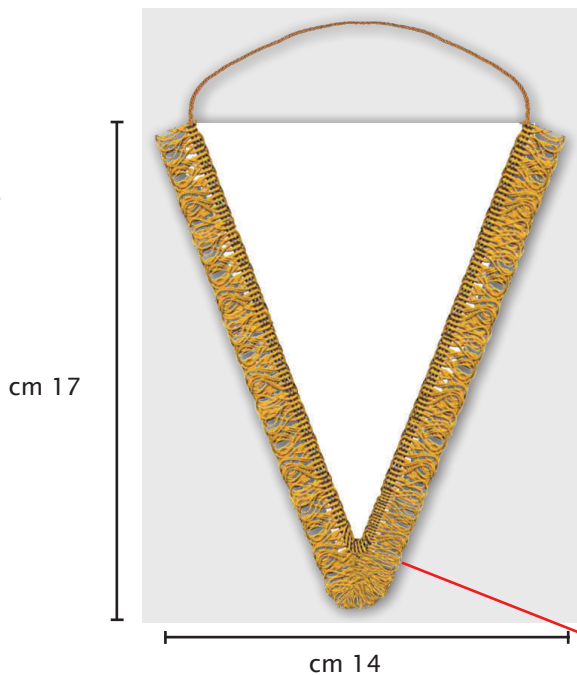

### FRANGIA CORDONETTO

fringe  
frange  
franse

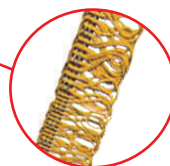

cm 1,5 (altezza)  
cm 1,5 (height)  
cm 1,5 (hauteur)  
cm 1,5 (höhe)

**Colori disponibili:**  
vedi pag. 63

Available colors :  
Couleurs disponibles : pag. 63  
Verfügen Farben :

### CORDINO - Ø mm 2

rope  
cordon  
Kordel



colore abbinato alla frangia  
color combined with the fringe  
couleur assortie à la frange  
farbe kombinierte die Fransen

**Colori disponibili:**  
vedi pag. 64

Available colors :  
Couleurs disponibles : pag. 64  
Verfügen Farben :

Material available :  
Matériel disponible : **Materiale disponibile**  
Material verfügbar :

Tipologia di stampa :  
Type of printing :  
Type d'impression :  
Art der Druck :

<b>raso</b> satin	<b>digitale</b> digital numérique <b>neutro</b> neutral neutre neutral
<b>raso Eco</b> cheap satin satin économique wirtschafts satin	<b>digitale</b> digital numérique

**Imbottitura disponibile** : available padding  
: rembourrage disponible  
: Polsterung verfügbar

**cartoncino** (cardboard - carton - karton)

### Varianti di modello disponibili

Model's variants available  
Variantes modèle disponibles  
Modellvarianten zur verfügung

**A** - cm 12,5x15,5 (busta)  
**B** - cm 17x18,5  
**C** - cm 13x16 (busta)  
**E** - cm 12,5x15,5 + fiocco  
**G** - cm 12,5x15,5 (busta)  
(solo cucitura)

pag.20

DE IN IT



# MODELLO 34

cm 17x18,5 comprensivo di frangia

## Triangolare con cordino cucito, senza busta.

Triangular with sewn rope, without envelope.

Triangulaire avec cordon, sans pochette.

Dreieckig mit Kordel, Umschlag.

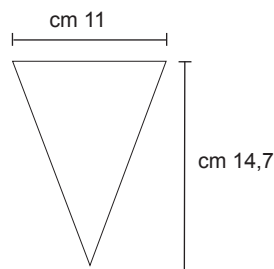

### AREA MASSIMA DI PERSONALIZZAZIONE:

la grafica dovrà essere inserita all'interno dell'area.

MAXIMUM AREA FOR CUSTOMIZATION:  
graphics should be included inside the lines.

ZONE MAXIMALE DE MARQUAGE:  
le graphique devra être inséré à l'intérieur de la zone.

HÖCHSTFLÄCHE DER PERSONALISIERUNG:  
die grafiken sollten die Grafik sollte.

### FRANGIA TRIPOLINO

fringe  
frange  
franse

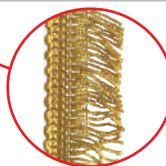

cm 3 (altezza)  
cm 3 (height)  
cm 3 (hauteur)  
cm 3 (höhe)

Colori disponibili:  
vedi pag. 63

Available colors :  
Couleurs disponibles : pag. 63  
Verfügen Farben :

### CORDINO - Ø mm 2

lanyard  
cordon  
Kordel



colore abbinato alla frangia  
color combined with the fringe  
couleur assortie à la frange farbe  
kombinierte die Fransen

Colori disponibili:  
vedi pag. 64

Available colors :  
Couleurs disponibles : pag. 64  
Verfügen Farben :

Material available :  
Matériel disponible : **Materiale disponibile**  
Material verfügbar :

Tipologia di stampa :  
Type of printing :  
Type d'impression :  
Art der Druck :

<b>raso</b> satin	<b>digitale</b> digital numérique <b>neutro</b> (interno cartoncino) neutre (carton fin interne) neutral (Internal-Karte)
<b>raso Eco</b> cheap satin satin économique wirtschafts satin	<b>digitale</b> digital numérique

**Imbottitura disponibile** : available padding  
: rembourrage disponible  
: Polsterung verfügbar

**cartoncino** (cardboard - carton - karton)

### Varianti di modello disponibili

Model's variants available  
Variantes modèle disponibles  
Modellvarianten zur verfügung

**A** - cm 12,5x15,5 (busta)  
**B** - cm 17x18,5  
**C** - cm 13x16 (busta)  
**E** - cm 12,5x15,5 + fiocco  
**G** - cm 12,5x15,5  
(solo cucitura) + busta

pag.20

GAGLIARDETTI  
pennant  
fanion  
wimpel

# MODELLO 6

cm 23x28,5 comprensivo di frangia

## Triangolare con frangia, bacchetta, cordino, busta.

Triangle with rope, fringe, envelope, wand.

Triangulaire avec frange, baguette, cordon, enveloppe.

Dreieckig mit Kordel, Fransen Umschlag.

GAGLIARDETTI  
pennant  
fanion  
wimpel

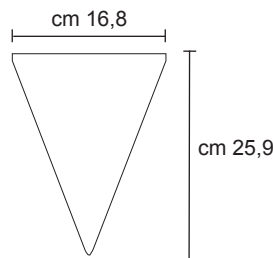

### AREA MASSIMA DI PERSONALIZZAZIONE:

la grafica dovrà essere inserita all'interno dell'area.

MAXIMUM AREA FOR CUSTOMIZATION:  
graphics should be included inside the lines.

ZONE MAXIMALE DE MARQUAGE:  
le graphique devra être inséré à l'intérieur de la zone.

HÖCHSTFLÄCHE DER PERSONALISIERUNG:  
die grafiken sollten die Grafik sollte.

### FRANGIA CORDONETTO

fringe  
frange  
franse

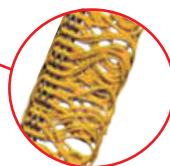

cm 3 (altezza)  
cm 3 (height)  
cm 3 (hauteur)  
cm 3 (höhe)

Colori disponibili:  
vedi pag. 63

Available colors :  
Couleurs disponibles : pag. 63  
Verfügen Farben :

### CORDINO - Ø mm 3

rope  
cordon  
Kordel



colore abbinato alla frangia  
color combined with the fringe  
couleur assortie à la frange  
farbe kombinierte die Fransen

Colori disponibili:  
vedi pag. 64

Available colors :  
Couleurs disponibles : pag. 64  
Verfügen Farben :

### BORCHIA - Ø mm 7

stud  
clou  
chef



Disponibile in OTTONE DORATO o OTTONE CROMATO

Available in golden or chrome brass  
Disponibile en laiton doré ou chromé  
Verfügbar in gold oder Verchromt Messing

Material available :  
Matériel disponible : **Materiale disponibile**  
Material verfügbar :

Tipologia di stampa :  
Type of printing :  
Type d'impression :  
Art der Druck :

<b>raso</b> satin	<b>digitale</b> digital numérique
<b>raso Eco</b> cheap satin satin économique wirtschafts satin	<b>neutro</b> (interno cartoncino) neutral (internal cardboard) neutre (carton fin interne) neutral (Internal-Karte)
<b>raso turco</b> turkish satin satin turc satin türkisch	<b>digitale</b> digital numérique
	<b>ricamo</b> embroidery broderie stickerei

**Imbottitura disponibile** : available padding  
rembourrage disponible  
Polsterung verfügbar

**spugna** (sponge - éponge - schwamm)  
**cartoncino** (cardboard - carton - karton)

### Varianti di modello disponibili

Model's variants available  
Variantes de modèle disponibles  
Modellvarianten zur verfügung

A - cm 20x27  
C - cm 20,5x27,5  
D - cm 28,5x23 (busta)  
E - cm 20x27 + fiocco  
F - cm 21x28  
G - cm 20x27  
(solo cucitura)

pag.20



# MODELLO 19

cm 21,5x33,5

## Triangolare con cordino, bacchetta, busta.

Triangular with rope, wand and envelope.

Triangulaire avec cordon, baguette, pochette.

Dreieckig mit Kordel, Umschlag.

GAGLIARDETTI  
pennant  
fanion  
wimpel

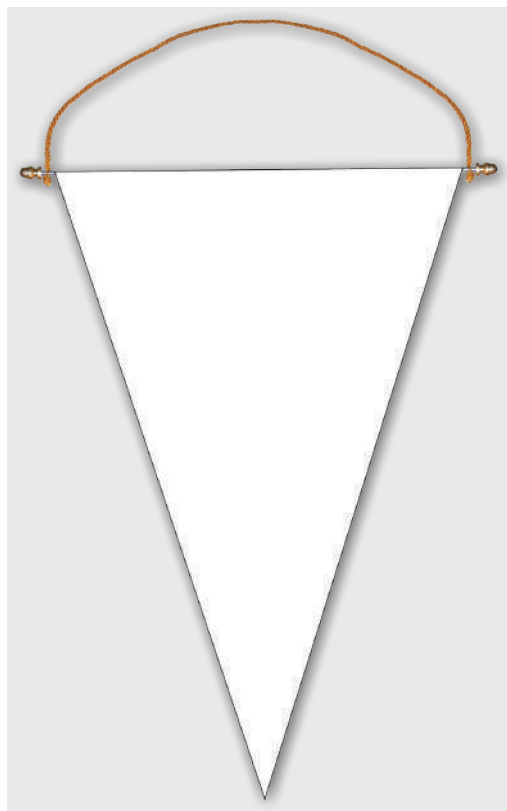

cm 33,5

cm 21,5

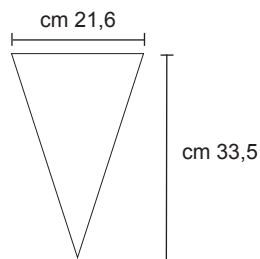

### AREA MASSIMA DI PERSONALIZZAZIONE:

la grafica dovrà essere inserita all'interno dell'area.

MAXIMUM AREA FOR CUSTOMIZATION:  
graphics should be included inside the lines.

ZONE MAXIMALE DE MARQUAGE:  
le graphique devra être inséré à l'intérieur de la zone.

HÖCHSTFLÄCHE DER PERSONALISIERUNG:  
die grafiken sollten die Grafik sollte.

### CORDINO - Ø mm 3

rope  
cordon  
Kordel



colore a scelta  
color of your choice  
couleur au choix  
Farbwahl

Colori disponibili:  
vedi pag. 64

Available colors :  
Couleurs disponibles : pag. 64  
VerfügenFarben :

### BORCHIA - Ø mm 9

stud  
clou  
chef



Disponibile in OTTONE DORATO o  
OTTONE CROMATO

Available in golden or chrome brass  
Disponible en laiton doré ou chromé  
Verfügbar in gold oder Verchromt Messing

Material available :  
Matériel disponible :  
Material verfügbar :

**Materiale disponibile**

**Tipologia di stampa**

Type of printing  
Type d'impression  
Art der Druck

<b>raso</b> satin	<b>digitale</b> digital numérique <b>neutro</b> (interno cartoncino) neutral (internal cardboard) neutre (carton fin interne) neutral (Internal-Karte)
<b>raso Eco</b> cheap satin satin économique wirtschafts satin	<b>digitale</b> digital numérique
<b>raso turco</b> turkish satin satin turc satin türkisch	<b>ricamo</b> embroidery broderie stickerei

**Imbottitura disponibile**

available padding  
rembourrage disponible  
Polsterung verfügbar

**spugna** (sponge - éponge - schwamm)

**cartoncino** (cardboard - carton - karton)

**Varianti di modello disponibili**

Model's variants available  
Variantes de modèle disponibles  
Modellvarianten zur verfügung

A - cm 21,5x33,5 (busta)  
B - cm 26,5x34,5 (busta)  
C - cm 22x34 (busta)  
D - cm 26,5x34,5 (busta)  
E - cm 21,5x33,5 + fiocco  
F - cm 23x32,5

pag.20



# MODELLO 1/f

cm 26,5x34,5 comprensivo di frangia  
- escluso fiocco -

## Triangolare con frangia, fiocco, bacchetta, cordino, busta.

Triangular with fringe, tassel, wand, rope, envelope.

Triangulaire avec frange, pompon, baguette, cordon, pochette.

Dreieckige, mit Fransen, Bausch, Stab, Kordel, Umschlag.

GAGLIARDETTI  
pennant  
fanion  
wimpel

cm 34,5

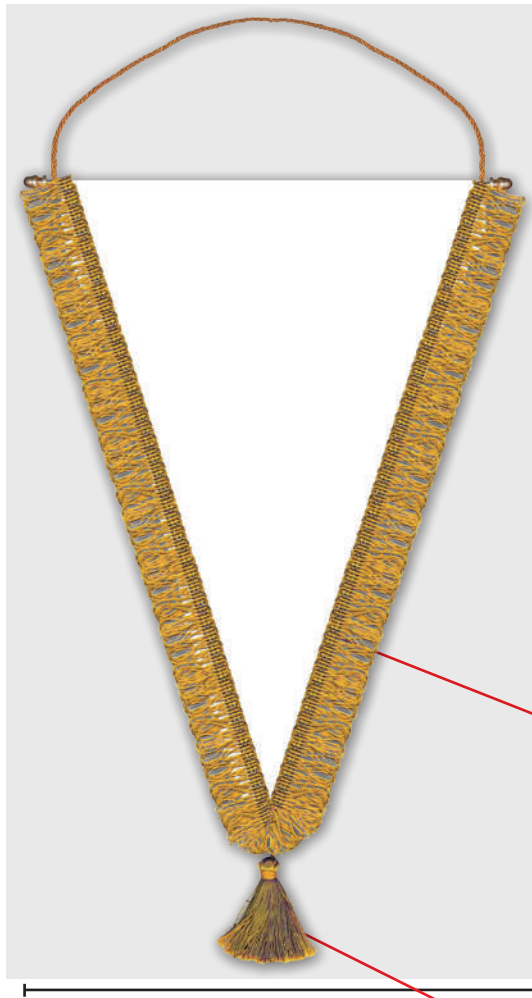

cm 26,5

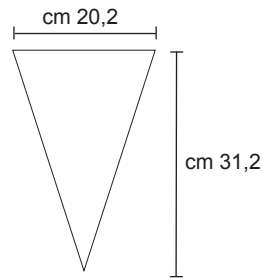

### AREA MASSIMA DI PERSONALIZZAZIONE:

la grafica dovrà essere inserita all'interno dell'area.

### MAXIMUM AREA FOR CUSTOMIZATION:

graphics should be included inside the lines.

### ZONE MAXIMALE DE MARQUAGE:

le graphique devra être inséré à l'intérieur de la zone.

### HÖCHSTFLÄCHE DER PERSONALISIERUNG:

die grafiken sollten die Grafik sollte.

### FRANGIA CORDONETTO

fringe  
frange  
franse

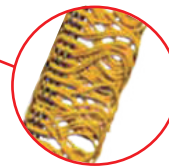

cm 3 (altezza)  
cm 3 (height)  
cm 3 (hauteur)  
cm 3 (höhe)

Colori disponibili:  
vedi pag. 63

Available colors :  
Couleurs disponibles : pag. 63  
Verfügen Farben :

### FIOCCO cm 5

tassel  
pompon  
bogen



colore abbinato alla frangia  
color combined with the fringe  
couleur assortie à la frange  
farbe kombinierte die Fransen/bogen

Colori disponibili:  
vedi pag. 63

Available colors :  
Couleurs disponibles : pag. 63  
Verfügen Farben :

### CORDINO - Ø mm 3

rope  
cordon  
Kordel



colore abbinato alla frangia /fiocco  
color combined with the fringe/tassel  
couleur combiné la frange/pompon  
farbe kombinierte die Fransen/bogen

Colori disponibili:  
vedi pag. 64

Available colors :  
Couleurs disponibles : pag. 64  
Verfügen Farben :

### BORCHIA - Ø mm 9

stud  
clou  
chef



Disponibile in OTTONE DORATO o  
OTTONE CROMATO

Available in golden or chrome brass  
Disponibile en laiton doré ou chromé  
Verfügbar in gold oder Verchromt Messing

Material available :  
Matériel disponible : **Materiale disponibile**  
Material verfügbar :

Tipologia di stampa :  
Type of printing :  
Type d'impression :  
Art der Druck :

<b>raso</b> satin	<b>digitale</b> digital numérique
<b>raso Eco</b> cheap satin satin économique wirtschafts satin	<b>neutro</b> (interno cartoncino) neutral (internal cardboard) neutre (carton fin interne) neutral (Internal-Karte)
<b>raso turco</b> turkish satin satin turc satin türkisch	<b>ricamo</b> embroidery broderie stickerei

**Imbottitura disponibile** : available padding  
rembourrage disponible  
Polsterung verfügbar

**spugna** (sponge - éponge - schwamm)  
**cartoncino** (cardboard - carton - karton)

### Varianti di modello disponibili

Model's variants available  
Variantes de modèle disponibles  
Modellvarianten zur verfügung

- A - cm 21,5x32 (busta)
- B - cm 26,5x34,5 (busta)
- C - cm 22x34 (busta)
- D - cm 26,5x34,5 (busta)
- E - cm 21,5x33,5 + fiocco
- F - cm 23x32,5

pag.20



# MODELLO 1

cm 32x39 comprensivo di frangia

## Triangolare con frangia, bacchetta, cordino, busta.

Triangular with fringe, wand, rope, envelope.

Triangulaire avec frange, baguette, cordon, pochette

Dreieckige, mit Fransen, Stab, Kordel, Umschlag.

GAGLIARDETTI  
pennant  
fanion  
wimpel

cm 39



cm 32

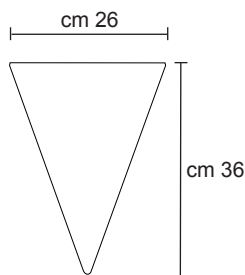

### AREA MASSIMA DI PERSONALIZZAZIONE:

la grafica dovrà essere inserita all'interno dell'area.

MAXIMUM AREA FOR CUSTOMIZATION:  
graphics should be included inside the lines.

ZONE MAXIMALE DE MARQUAGE:  
le graphique devra être inséré à l'intérieur de la zone.

HÖCHSTFLÄCHE DER PERSONALISIERUNG:  
die grafiken sollten die Grafik sollte.

### FRANGIA CORDONETTO

fringe  
frange  
franse

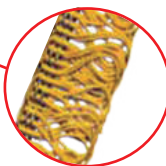

cm 3 (altezza)  
cm 3 (height)  
cm 3 (hauteur)  
cm 3 (höhe)

Colori disponibili:  
vedi pag.63

Available colors :  
Couleurs disponibles : pag. 63  
Verfügen Farben :

### CORDINO - Ø mm 3

rope  
cordon  
Kordel



colore abbinato alla frangia  
color combined with the fringe  
couleur assortie à la frange  
farbe kombinierte die Fransen

Colori disponibili:  
vedi pag. 64

Available colors :  
Couleurs disponibles : pag. 64  
Verfügen Farben :

### BORCHIA - Ø mm 9

stud  
clou  
chef



Disponibile in OTTONE DORATO o OTTONE CROMATO

Available in golden or chrome brass  
Disponible en laiton doré ou chromé  
Verfügbar in gold oder Verchromt Messing

Material available :  
Matériel disponible :  
Material verfügbar :

### Materiale disponibile

<b>raso</b> satin	
<b>raso Eco</b> cheap satin satin économique wirtschafts satin	<b>digitale</b> digital numérique
<b>raso turco</b> turkish satin satin turc satin türkisch	<b>ricamo</b> embroidery broderie stickerei

### Tipologia di stampa

Type of printing  
Type d'impression  
Art der Druck

<b>digitale</b> digital numérique
<b>neutro</b> (interno cartoncino) neutral (internal cardboard) neutre (carton fin interne) neutral (Internal-Karte)

### Imbottitura disponibile

available padding  
rembourrage disponible  
Polsterung verfügbar

<b>spugna</b> (sponge - éponge - schwamm)
<b>cartoncino</b> (cardboard - carton - karton)

### Varianti di modello disponibili

Model's variants available  
Variantes de modèle disponibles  
Modellvarianten zur verfügung

- A - cm 27,5x36,5
- C - cm 28x37
- D - cm 32x39 (busta)
- E - cm 27,5x36,5 + fiocco
- F - cm 29x37,5
- G - cm 27,5x36,5 (solo cucitura)

pag.20

# MODELLO 20

cm 33,5x40 comprensivo di frangia

## Triangolare con frangia, bacchetta, cordino, busta.

Triangle with cord, fringe envelope, wand.

Triangulaire avec cordon, frange pochette baguette.

Dreieckige, mit Fransen, Stab, Kordel, Umschlag.

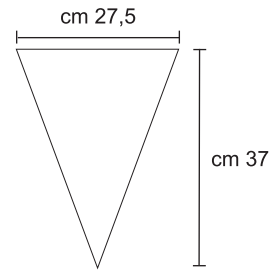
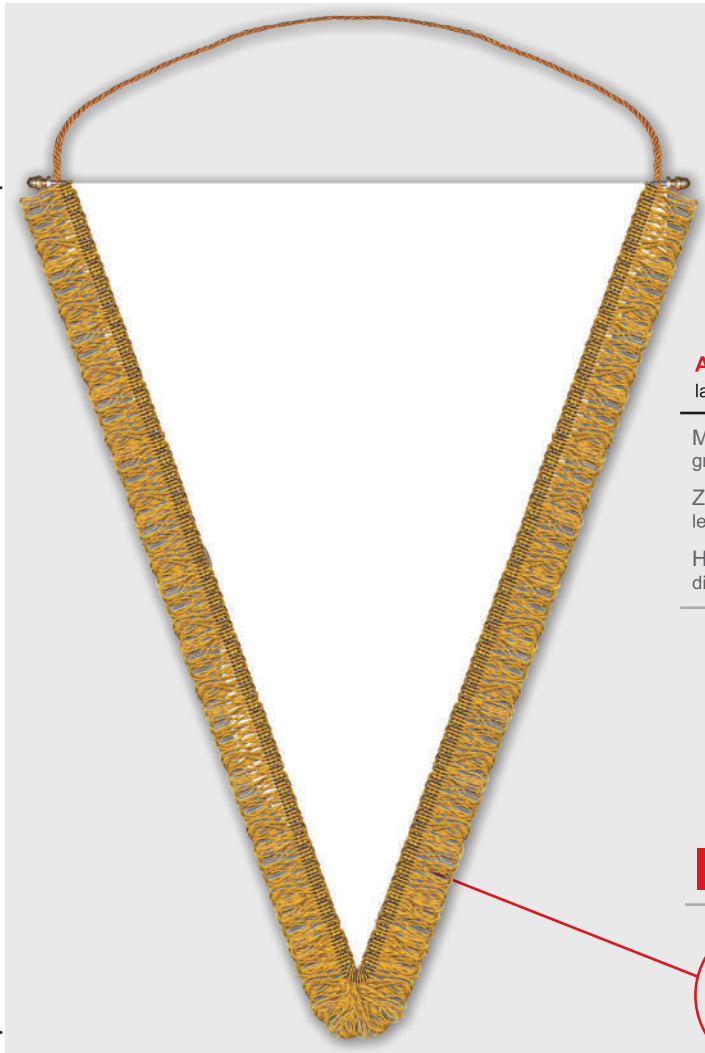

**AREA MASSIMA DI PERSONALIZZAZIONE:**  
la grafica dovrà essere inserita all'interno dell'area.

**MAXIMUM AREA FOR CUSTOMIZATION:**  
graphics should be included inside the lines.

**ZONE MAXIMALE DE MARQUAGE:**  
le graphique devra être inséré à l'intérieur de la zone.

**HÖCHSTFLÄCHE DER PERSONALISIERUNG:**  
die grafiken sollten die Grafik sollte.

### FRANGIA CORDONETTO

fringe  
frange  
franse



cm 3 (altezza)  
cm 3 (height)  
cm 3 (hauteur)  
cm 3 (höhe)

**Colori disponibili:**  
vedi pag. 63

Available colors :  
Couleurs disponibles : pag. 63  
Verfügen Farben :

### CORDINO - Ø mm 3

rope  
cordon  
Kordel



colore abbinato alla frangia  
color combined with the fringe  
couleur assortie à la frange  
farbe kombinierte die Fransen

**Colori disponibili:**  
vedi pag. 64

Available colors :  
Couleurs disponibles : pag. 64  
Verfügen Farben :

### BORCHIA - Ø mm 9

stud  
clou  
chef



Disponibile in OTTONE DORATO o OTTONE CROMATO

Available in golden or chrome brass  
Disponible en laiton doré ou chromé  
Verfügbar in gold oder Verchromt Messing

GAGLIARDETTI  
pennant  
fanion  
wimpel

cm 40

cm 33,5

Material available :  
Matériel disponible :  
Material verfügbar :

#### Materiale disponibile

<b>raso</b> satin	
<b>raso Eco</b> cheap satin satin économique wirtschafts satin	<b>digitale</b> digital numérique
<b>raso turco</b> turkish satin satin turc satin türkisch	<b>ricamo</b> embroidery broderie stickerei

#### Tipologia di stampa

Type of printing  
Type d'impression  
Art der Druck

<b>digitale</b> digital numérique	
<b>neutro</b> (interno cartoncino) neutral (internal cardboard) neutre (carton fin interne) neutral (Internal-Karte)	

#### Imbottitura disponibile

available padding  
rembourrage disponible  
Polsterung verfügbar

<b>spugna</b> (sponge - éponge - schwamm)	
<b>cartoncino</b> (cardboard - carton - karton)	

#### Varianti di modello disponibili

Model's variants available  
Variantes de modèle disponibles  
Modellvarianten zur verfügung

- A - cm 29x37,5 (busta)
- C - cm 29,5x38 (busta)
- D - cm 33,5x40 (busta)
- E - cm 37,5x29 + fiocco
- F - cm 30,5x38,5
- G - cm 37,5x29 (solo cucitura)

pag.20



# MODELLO 42

cm 37,5x47 comprensivo di frangia

## Triangolare con frangia, bacchetta, cordino, busta.

Triangular with fringe, wand, rope, envelope.

Triangulaire avec une frange, baguette, cordon, pochette.

Dreieckige, mit Fransen, Stab, Kordel, Umschlag.

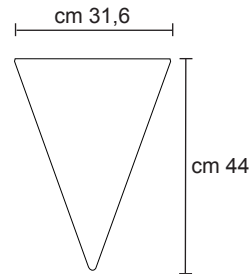
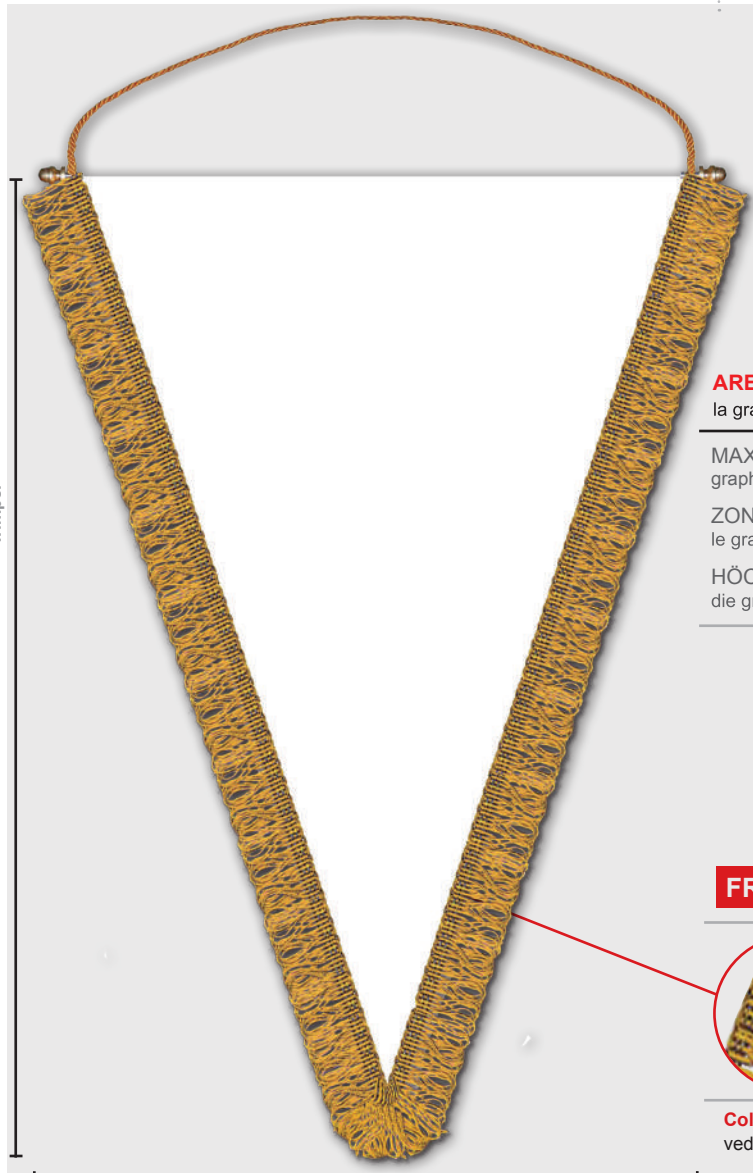

### AREA MASSIMA DI PERSONALIZZAZIONE:

la grafica dovrà essere inserita all'interno dell'area.

### MAXIMUM AREA FOR CUSTOMIZATION:

graphics should be included inside the lines.

### ZONE MAXIMALE DE MARQUAGE:

le graphique devra être inséré à l'intérieur de la zone.

### HÖCHSTFLÄCHE DER PERSONALISIERUNG:

die grafiken sollten die Grafik sollte.

### FRANGIA CORDONETTO

fringe  
frange  
franse

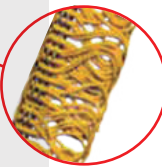

cm 3 (altezza)  
cm 3 (height)  
cm 3 (hauteur)  
cm 3 (höhe)

**Colori disponibili:**  
vedi pag. 63

Available colors :  
Couleurs disponibles : pag. 63  
Verfügen Farben :

### CORDINO - Ø mm 3

rope  
cordon  
Kordel



colore abbinato alla frangia  
color combined with the fringe  
couleur assortie à la frange  
farbe kombinierte die Fransen

**Colori disponibili:**  
vedi pag. 64

Available colors :  
Couleurs disponibles : pag. 64  
Verfügen Farben :

### BORCHIA - Ø mm 9

stud  
clou  
chef



Disponibile in OTTONE DORATO o OTTONE CROMATO

Available in golden or chrome brass  
Disponible en laiton doré ou chromé  
Verfügbar in gold oder Verchromt Messing

GAGLIARDETTI  
pennant  
fanion  
wimpel

cm 47

cm 37,5

Material available :  
Matériel disponible :  
Material verfügbar :

**Materiale disponibile**

**Tipologia di stampa**

Type of printing  
Type d'impression  
Art der Druck

**raso** satin

**digitale** digital  
numérique

**neutro** (interno cartoncino)  
neutral (internal cardboard)  
neutre (carton fin interne)  
neutral (Internal-Karte)

**raso turco** turkish satin  
satin turc  
satin türkisch

**ricamo** embroidery  
broderie  
stickerei

**Imbottitura disponibile**

available padding  
rembourrage disponible  
Polsterung verfügbar

**spugna** (sponge - éponge - schwamm)  
**cartoncino** (cardboard - carton - karton)

**Varianti di modello disponibili**

Model's variants available  
Variantes modèle disponibles  
Modellvarianten zur verfügung

**A** - cm 33x44,5  
**C** - cm 33,5x45 (busta)  
**D** - cm 37,5x47 (busta)  
**E** - cm 33x44,5 + fiocco  
**F** - cm 34,5x45,5  
**G** - cm 33x44,5  
(solo cucitura)

pag.20

**VARIANTE A**

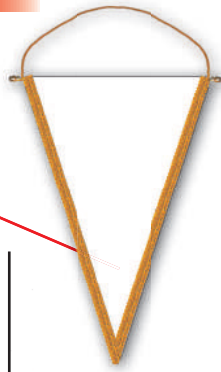

**Triangolare con passamaneria (cm 1).**

Triangular with trimming.  
 Triangulaire avec passemanerie  
 Dreieckig mit Pasament.

**Colori disponibili:** Available colors  
 vedi pag. 63 Couleurs disponibles  
 Verfügen Farben pag. 63

**VARIANTE B**

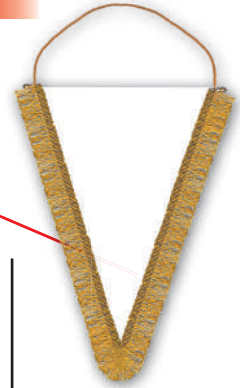
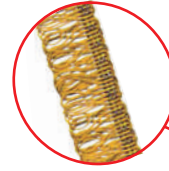

**Triangolare con frangia cordonetto (cm 3).**

Triangular with fringe and rope.  
 Triangulaire avec une frange.  
 Dreieckig mit Fransen.

**Colori disponibili:** Available colors  
 vedi pag. 63 Couleurs disponibles  
 Verfügen Farben pag. 63

**VARIANTE C**

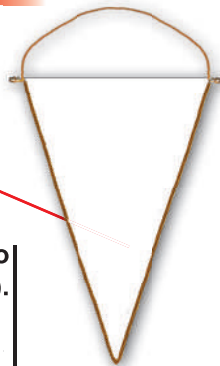

**Triangolare con cordino perimetrale (Ø 4 mm).**

Triangular with perimetric rope  
 Triangulaire avec cordon. périmétral.  
 Dreieckig mit Lanyard Umfang.

**Colori disponibili:** Available colors  
 vedi pag. 64 Couleurs disponibles  
 Verfügen Farben pag. 64

**VARIANTE D**

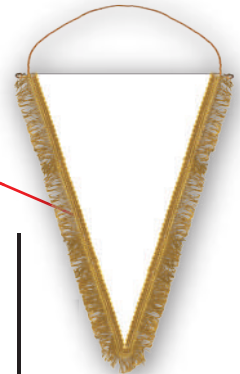

**Triangolare con frangia tripolino (cm 3).**

Triangular with Tripoli.  
 Triangulaire avec Tripoli.  
 Dreieckig mit Tripolis.

**Colori disponibili:** Available colors  
 vedi pag. 63 Couleurs disponibles  
 Verfügen Farben pag. 63

**VARIANTE E**

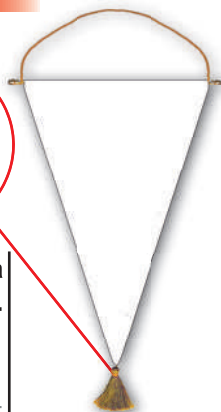

**Triangolare solo cucitura con fiocco (cm 5).**

Triangular only sewn with tassel.  
 Triangulaire couture avec pompon.  
 Dreieckige nur Naht mit Schleife.

**Colori disponibili:** Available colors  
 vedi pag. 63 Couleurs disponibles  
 Verfügen Farben pag. 63

**VARIANTE F**

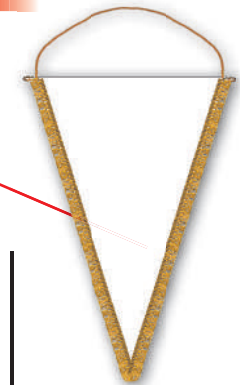

**Triangolare con frangia cordonetto (cm 1,5).**

Triangular with fringe.  
 Triangulaire avec frange  
 Dreieckig mit Fransen.

**Colori disponibili:** Available colors  
 vedi pag. 63 Couleurs disponibles  
 Verfügen Farben pag. 63

**N.B.**

Cordino e bacchetta, ove previsti, non variano rispetto al modello scelto.  
 La presenza della busta è specificata dalla variante del modello scelto.

Rope and wand, if provided, do not vary compared to the model chosen. The presence of the envelope is specified by the type of the chosen model.

Cordon et baguette, si fournis, ne varient pas par rapport au modèle choisi. La présence de la pochette est définie par la typologie du modèle choisi.

Kordel und Stab, wenn verfügbar, variieren sie nicht in bezug auf das gewählte Modell.



# MODELLO 12

cm 11,5x13 comprensivo di frangia

## Pentagonale con frangia, cordino cucito, busta.

Pentagonal with sewn rope and envelope.

Pentagonale avec frange, cordon cousu, pochette.

Fünfeckung mit genäht Kordel, Umschlag.

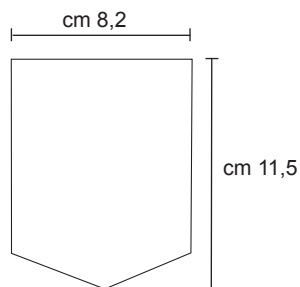

### AREA MASSIMA DI PERSONALIZZAZIONE:

la grafica dovrà essere inserita all'interno dell'area.

MAXIMUM AREA FOR CUSTOMIZATION: graphics should be included inside the lines.

ZONE MAXIMALE DE MARQUAGE: le graphique devra être inséré à l'intérieur de la zone.

HÖCHSTFLÄCHE DER PERSONALISIERUNG: die grafiken sollten die Grafik sollte.

GAGLIARDETTI  
pennant  
fanion  
wimpel

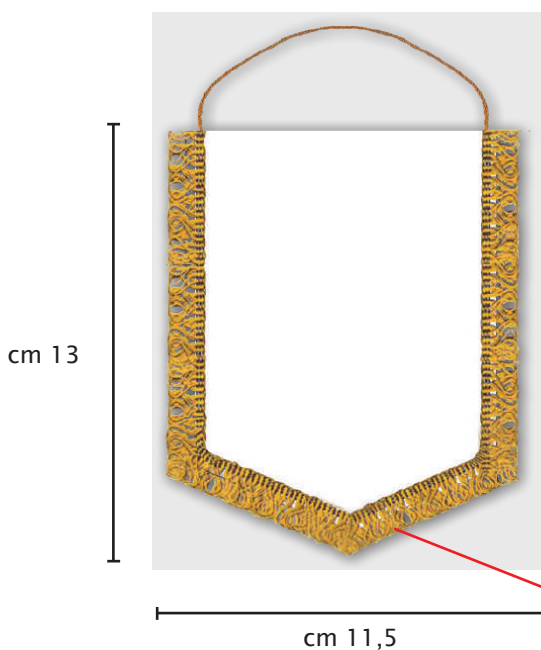

### FRANGIA CORDONETTO

fringe  
frange  
franse



cm 1,5 (altezza)  
cm 1,5 (height)  
cm 1,5 (hauteur)  
cm 1,5 (höhe)

Colori disponibili:  
vedi pag. 63

Available colors :  
Couleurs disponibles : pag. 63  
Verfügen Farben :

### CORDINO - Ø mm 2

rope  
cordon  
Kordel



colore abbinato alla frangia  
color combined with the fringe  
couleur assortie à la frange  
farbe kombinierte die Fransen

Colori disponibili:  
vedi pag. 64

Available colors :  
Couleurs disponibles : pag. 64  
Verfügen Farben :

Material available :  
Matériel disponible :  
Material verfügbar :

**Materiale disponibile**

**Tipologia di stampa**

Type of printing  
Type d'impression  
Art der Druck

<b>raso</b> satin	<b>digitale</b> digital numérique neutral (internal cardboard) <b>neutro</b> (interno cartoncino) neutre (carton fin interne) neutral (Internal-Karte)
<b>raso Eco</b> cheap satin satin économique wirtschafts satin	<b>digitale</b> digital numérique

**Imbottitura disponibile**

available padding  
rembourrage disponible  
Polsterung verfügbar

**cartoncino** (cardboard - carton - karton)

**Varianti di modello disponibili**

Model's variants available  
Variantes modèle disponibles  
Modellvarianten zur Verfügung

**A** - cm 9,5x12 (busta)  
**B** - cm 14x14,5  
**C** - cm 10,5x12,5 (busta)  
**E** - cm 9,5x12 + fiocco  
**G** - cm 9,5x12 (solo cucitura) + busta

pag.35

# MODELLO 18

cm 14x14,5 comprensivo di frangia

## Pentagonale con cordino cucito, senza busta.

Pentagonal sewn rope, fringe, envelope.

Pentagonale avec cordon cousu sans pochette.

Fünfeckung mit genäht Kordel, Umschlag.

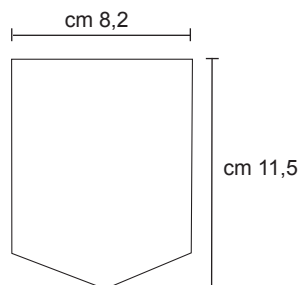

### AREA MASSIMA DI PERSONALIZZAZIONE:

la grafica dovrà essere inserita all'interno dell'area.

MAXIMUM AREA FOR CUSTOMIZATION: graphics should be included inside the lines.

ZONE MAXIMALE DE MARQUAGE: le graphique devra être inséré à l'intérieur de la zone.

HÖCHSTFLÄCHE DER PERSONALISIERUNG: die grafiken sollten die Grafik sollte.

GAGLIARDETTI  
pennant  
fanion  
wimpel

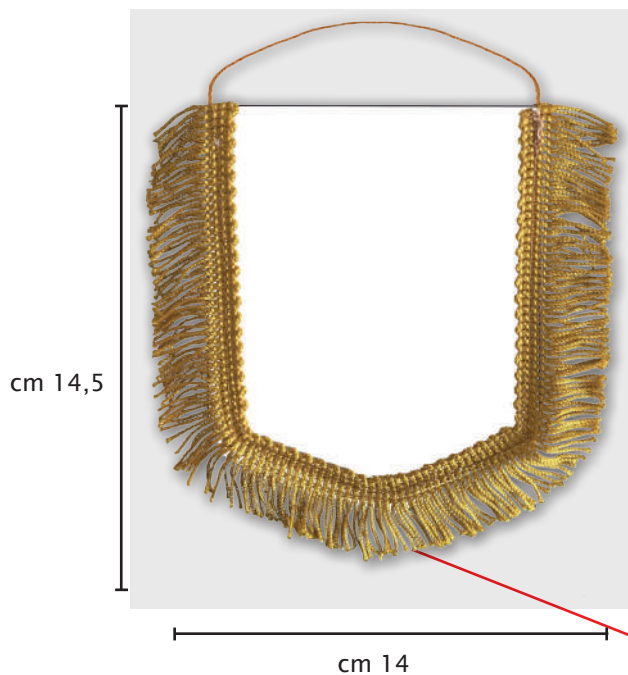

### FRANGIA TRIPOLINO

fringe  
frange  
franse

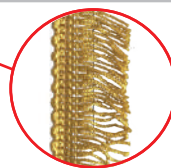

cm 3 (altezza)  
cm 3 (height)  
cm 3 (hauteur)  
cm 3 (höhe)

Colori disponibili:  
vedi pag. 63

Available colors :  
Couleurs disponibles : pag. 63  
Verfügen Farben :

### CORDINO - Ø mm 2

rope  
cordon  
Kordel



colore abbinato alla frangia  
color combined with the fringe  
couleur assortie à la frange  
farbe kombinierte die Fransen

Colori disponibili:  
vedi pag. 64

Available colors :  
Couleurs disponibles : pag. 64  
Verfügen Farben :

Material available : Matériel disponible : Material verfügbar :	<b>Materiale disponibile</b>	<b>Tipologia di stampa</b>	Type of printing : Type d'impression : Art der Druck :
	<b>raso satin</b>	<b>digitale</b> digital numérique <b>neutro</b> (interno cartoncino) neutral (internal cardboard) neutre (carton fin interne) neutral (Internal-Karte)	
	<b>raso Eco</b> cheap satin satin économique wirtschafts satin	<b>digitale</b> digital numérique	

### Imbottitura disponibile

available padding  
rembourrage disponible  
Polsterung verfügbar

**cartoncino** (cardboard - carton - karton)

### Varianti di modello disponibili

Model's variants available:  
Variantes modèle disponibles  
Modellvarianten zur verfügung

**A** - cm 9,5x12 (busta)  
**B** - cm 14x14,5  
**C** - cm 10,5x12,5 (busta)  
**E** - cm 9,5x12 + fiocco  
**G** - cm 9,5x12  
(solo cucitura) + busta

pag.35

DE IN IT



# MODELLO 13

cm 17,5x21,5 comprensivo di frangia

## Pentagonale con frangia, cordino cucito, busta.

Pentagonal with sewn rope, frange and envelope. : Pentagonale avec frange, cordon cousu, pochette. : Fünfeckig mit genäht Kordel, Umschlag.

GAGLIARDETTI  
pennant  
fanion  
wimpel

cm 21,5



cm 17,5

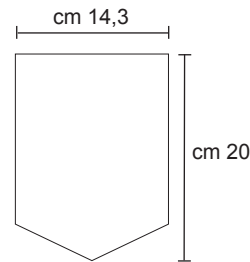

### AREA MASSIMA DI PERSONALIZZAZIONE:

la grafica dovrà essere inserita all'interno dell'area.

MAXIMUM AREA FOR CUSTOMIZATION:  
graphics should be included inside the lines.

ZONE MAXIMALE DE MARQUAGE:  
le graphique devra être inséré à l'intérieur de la zone.

HÖCHSTFLÄCHE DER PERSONALISIERUNG:  
die grafiken sollten die Grafik sollte.

### FRANGIA CORDONETTO

fringe  
frange  
franse

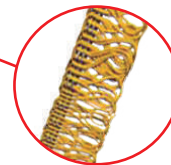

cm 1,5 (altezza)  
cm 1,5 (height)  
cm 1,5 (hauteur)  
cm 1,5 (höhe)

Colori disponibili:  
vedi pag. 63

Available colors :  
Couleurs disponibles : pag. 63  
Verfügen Farben :

### CORDINO - Ø mm 3

rope  
cordon  
Kordel



colore abbinato alla frangia  
color combined with the fringe  
couleur assortie à la frange  
farbe kombinierte die Fransen

Colori disponibili:  
vedi pag. 64

Available colors :  
Couleurs disponibles : pag. 64  
Verfügen Farben :

Material available :  
Matériel disponible : **Materiale disponibile**  
Material verfügbar :

Tipologia di stampa :  
Type of printing :  
Type d'impression :  
Art der Druck :

<b>raso</b> satin	<b>digitale</b> digital numérique
<b>raso Eco</b> cheap satin satin économique wirtschafts satin	<b>neutro</b> (interno cartoncino) neutral (internal cardboard) neutre (carton fin interne) neutral (Internal-Karte)
<b>raso turco</b> turkish satin satin turc satin türkisch	<b>digitale</b> digital numérique
	<b>ricamo</b> embroidery broderie stickerei

**Imbottitura disponibile** : available padding  
: rembourrage disponible  
: Polsterung verfügbar

**spugna** (sponge - éponge - schwamm)  
**cartoncino** (cardboard - carton - karton)

### Varianti di modello disponibili

Model's variants available  
Variantes de modèle disponibles  
Modellvarianten zur verfügung

**A** - cm 15,5x20,5 (busta)  
**B** - cm 20,5x23  
**C** - cm 16x21  
**D** - cm 20,5x23  
**E** - cm 15,5x20,5 + fiocco  
**G** - cm 15,5x20,5  
(solo cucitura)

pag.35



# MODELLO 16

cm 18,5x24,5 comprensivo di passamaneria - escluso fiocco -

## Pentagonale con passamaneria, fiocco, bacchetta, cordino, senza busta.

Pentagonal with rope, trimmings, tassel, wand, without envelope. : Pentagonal avec pas- sementerie, pompon, baguette, cordon, sans pochette. : Fünfeckig mit Posament, Bausch, Stab, Krodol, otine Umschlag

GAGLIARDETTI  
pennant  
fanion  
wimpel

cm 24,5

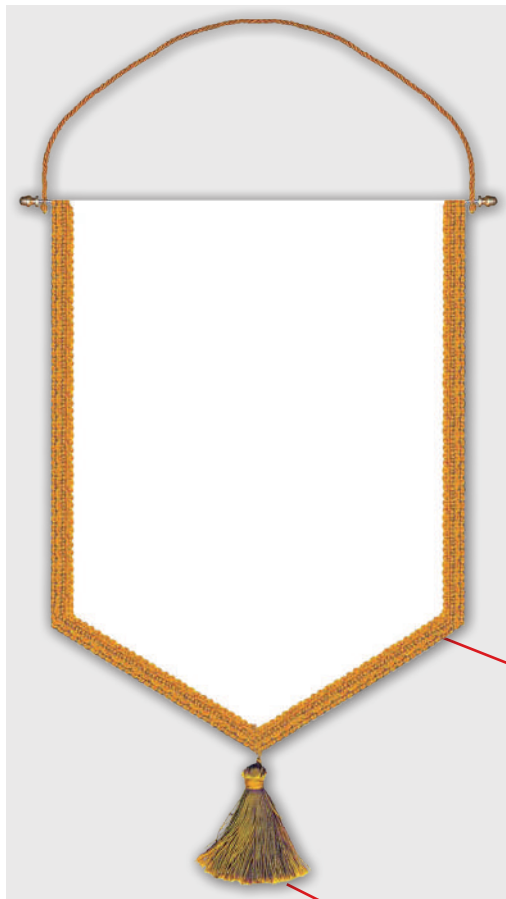

cm 18,5

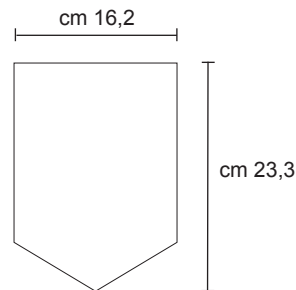

### AREA MASSIMA DI PERSONALIZZAZIONE:

la grafica dovrà essere inserita all'interno dell'area.

MAXIMUM AREA FOR CUSTOMIZATION:  
graphics should be included inside the lines.

ZONE MAXIMALE DE MARQUAGE:  
le graphique devra être inséré à l'intérieur de la zone.

HÖCHSTFLÄCHE DER PERSONALISIERUNG:  
die grafiken sollten die Grafik sollte.

### PASSAMANERIA

trimmings  
passementerie  
Posament

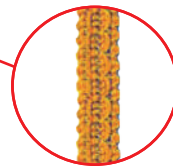

cm 1 (altezza)  
cm 1 (height)  
cm 1 (hauteur)  
cm 1 (höhe)

Colori disponibili:  
vedi pag. 63

Available colors :  
Couleurs disponibles : pag. 63  
Verfügen Farben :

### FIOCCO cm 5

tassel  
pompon  
bogen



colore abbinato alla passamaneria  
color combined with the trimmings  
couleur assortie à la passementerie  
farbe kombinierte die Verzierungen

Colori disponibili:  
vedi pag. 63

Available colors :  
Couleurs disponibles : pag. 63  
Verfügen Farben :

### CORDINO - Ø mm 3

lanyard  
cordon  
Kordel



colore abbinato alla passamaneria  
color combined with the trimmings  
couleur assortie à la passementerie  
farbe kombinierte die Verzierungen

Colori disponibili:  
vedi pag. 64

Available colors :  
Couleurs disponibles : pag. 64  
Verfügen Farben :

### BORCHIA - Ø mm 7

stud  
clou  
chef



Disponibile in OTTONE DORATO o OTTONE CROMATO

Available in golden or chrome brass  
Disponible en laiton doré ou chromé  
Verfügbar in gold oder Verchromt Messing

Material available :  
Matériel disponible :  
Material verfügbar :

**Materiale disponibile**

Tipologia di stampa :  
Type of printing :  
Type d'impression :  
Art der Druck :

<b>raso</b> satin	<b>digitale</b> digital numérique
<b>raso Eco</b> cheap satin satin économique wirtschafts satin	<b>digitale</b> digital numérique
<b>raso turco</b> turkish satin satin turc satin türkisch	<b>ricamo</b> embroidery broderie stickerei
	<b>neutro</b> (interno cartoncino) neutral (internal cardboard) neutre (carton fin interne) neutral (Internal-Karte)

**Imbottitura disponibile** : available padding  
: rembourrage disponible  
: Polsterung verfügbar

**spugna** (sponge - éponge - schwamm)  
**cartoncino** (cardboard - carton - karton)

### Varianti di modello disponibili

Model's variants available  
Variantes de modèle disponibles  
Modellvarianten zur verfügung

A - cm 18,5x24,5  
B - cm 21x26,5  
C - cm 19x24,5  
D - cm 21x26,5  
E - cm 18,5x24,5 + fiocco  
F - cm 19,5x25  
G - cm 18,5x24,5  
(solo cucitura)

pag.35



# MODELLO 17

cm 16,5x27,5

## Pentagonale con bacchetta, cordino, busta.

Pentagonal with rope, envelope, wand.

Pentagonal avec baguette, cordon, pochette.

Fünfeckung mit Krodel, Umschlag

GAGLIARDETTI  
pennant  
fanion  
wimpel

27,5 cm

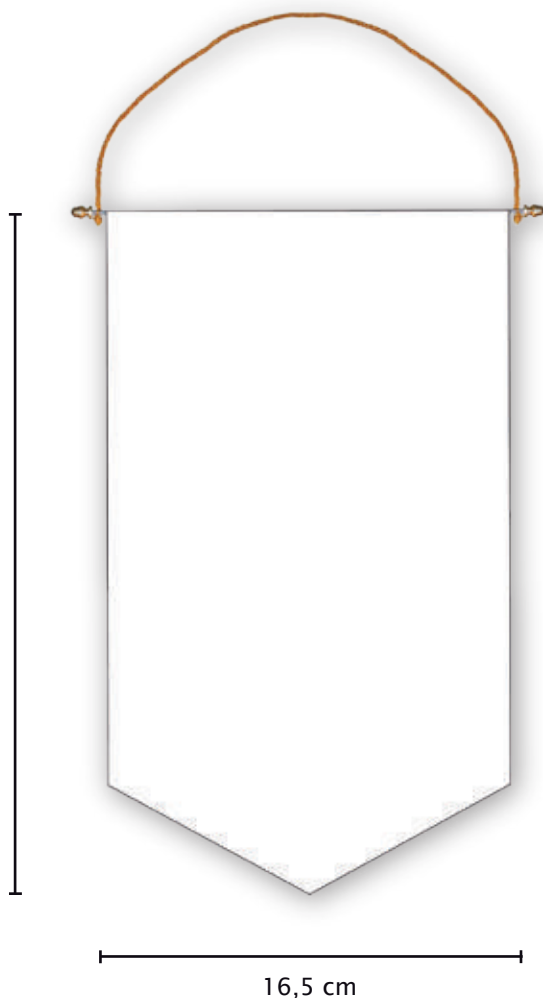

16,5 cm

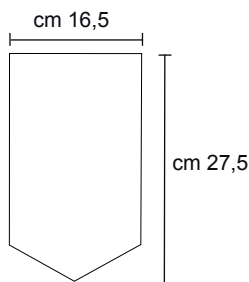

### AREA MASSIMA DI PERSONALIZZAZIONE:

la grafica dovrà essere inserita all'interno dell'area.

MAXIMUM AREA FOR CUSTOMIZATION:  
graphics should be included inside the lines.

ZONE MAXIMALE DE MARQUAGE:  
le graphique devra être inséré à l'intérieur de la zone.

HÖCHSTFLÄCHE DER PERSONALISIERUNG:  
die grafiken sollten die Grafik sollte.

### CORDINO - Ø mm 3

rope  
cordon  
Kordel



colore a scelta  
color of your choice  
couleur à choisir  
Farbwahl

Colori disponibili:  
vedi pag. 64

Available colors :  
Couleurs disponibles : pag.64  
Verfügen Farben :

### BORCHIA - Ø mm 7

stud  
clou  
chef



Disponibile in OTTONE DORATO o  
OTTONE CROMATO

Available in golden or chrome brass  
Disponible en laiton doré ou chromé  
Verfügbar in gold oder Verchromt Messing

Material available :  
Matériel disponible :  
Material verfügbar :

### Materiale disponibile

### Tipologia di stampa

Type of printing  
Type d'impression  
Art der Druck

<b>raso</b> satin	<b>digitale</b> digital numérique <b>neutro</b> (interno cartoncino) neutral (internal cardboard) neutre (carton fin interne) neutral (Internal-Karte)
<b>raso Eco</b> cheap satin satin économique wirtschafts satin	<b>digitale</b> digital numérique
<b>raso turco</b> turkish satin satin turc satin türkisch	<b>ricamo</b> embroidery broderie stickerei

### Imbottitura disponibile

available padding  
rembourrage disponible  
Polsterung verfügbar

**spugna** (sponge - éponge - schwamm)  
**cartoncino** (cardboard - carton - karton)

### Varianti di modello disponibili

Model's variants available  
Variantes de modèle disponibles  
Modellvarianten zur verfügung

**C** - cm 16,5x27,5 (busta)  
**D** - cm 21x30 (busta)  
**E** - cm 16,5x27,5 + fiocco

pag.35

# MODELLO 14

cm 16,5x27,5 comprensivo di passamaneria

## Pentagonale con passamaneria, bacchetta, cordino, busta.

Pentagonal with rope, fringe, envelope wand.

Pentagonal avec passementerie, baguette, cordon, pochette.

Fünfeckung mit Posament, Bausch, Krodel, otine Umschlag.

GAGLIARDETTI  
pennant  
fanion  
wimpel

cm 27,5

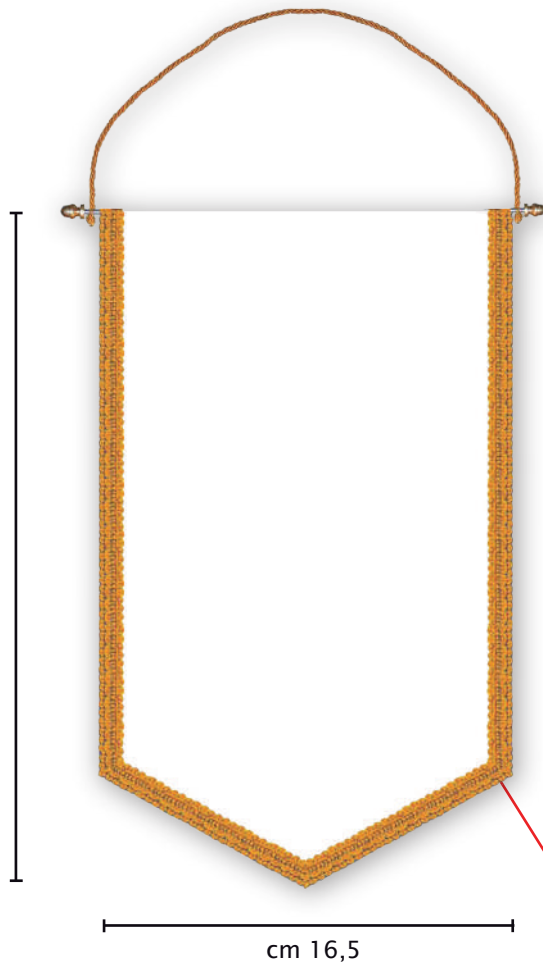

cm 16,5

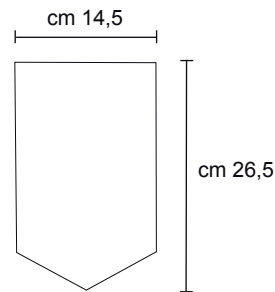

### AREA MASSIMA DI PERSONALIZZAZIONE:

la grafica dovrà essere inserita all'interno dell'area.

MAXIMUM AREA FOR CUSTOMIZATION:  
graphics should be included inside the lines.

ZONE MAXIMALE DE MARQUAGE:  
le graphique devra être inséré à l'intérieur de la zone.

HÖCHSTFLÄCHE DER PERSONALISIERUNG:  
die grafiken sollten die Grafik sollte.

### PASSAMANERIA

trimmings  
passementerie  
Verzierungen

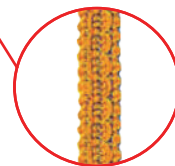

cm 1 (altezza)  
cm 1 (height)  
cm 1 (hauteur)  
cm 1 (höhe)

Colori disponibili:  
vedi pag. 63

Available colors :  
Couleurs disponibles : pag. 63  
Verfügen Farben :

### CORDINO - Ø mm 3

rope  
cordon  
Kordel



colore abbinato alla passamaneria  
color combined with the trimmings  
couleur assortie à la passementerie  
farbe kombinierte die Verzierungen

Colori disponibili:  
vedi pag.64

Available colors :  
Couleurs disponibles : pag.64  
Verfügen Farben :

### BORCHIA - Ø mm 7

stud  
clou  
chef



Disponibile in OTTONE DORATO o  
OTTONE CROMATO

Available in golden or chrome  
Disponible en laiton doré ou chromé  
Verfügbar in gold oder Verchromt Messing

Material available :  
Matériel disponible :  
Material verfügbar :

### Materiale disponibile

<b>raso</b> satin	
<b>raso Eco</b> cheap satin satin économique wirtschafts satin	<b>digitale</b> digitale numérique
<b>raso turco</b> turkish satin satin turc satin türkisch	<b>ricamo</b> embroidery broderie stickerei

### Tipologia di stampa

Type of printing  
Type d'impression  
Art der Druck

<b>digitale</b>	digital numérique
<b>neutro</b> (interno cartoncino)	neutral (internal cardboard) neutre (carton fin interne) neutral (Internal-Karte)

### Imbottitura disponibile

available padding  
rembourrage disponible  
Polsterung verfügbar

<b>spugna</b>	(sponge - éponge - schwamm)
<b>cartoncino</b>	(cardboard - carton - karton)

### Varianti di modello disponibili

Model's variants available  
Variantes de modèle disponibles  
Modellvarianten zur Verfügung

C - cm 16,5x27,5 (busta)  
D - cm 21x30 (busta)  
E - cm 16,5x27,5 + fiocco

pag.35



# MODELLO 43

cm 18x28,5 comprensivo di frangia

## Pentagonale con frangia, bacchetta, cordino, busta (adattata + larga)

Pentagonal with rope, trimmings, wand, without envelope. : Pentagonal avec cordon, frange, pochette, baguette. : Fünfeckig mit Posament, Bausch, Stab, Krodol, otine Umschlag

GAGLIARDETTI  
pennant  
fanion  
wimpel

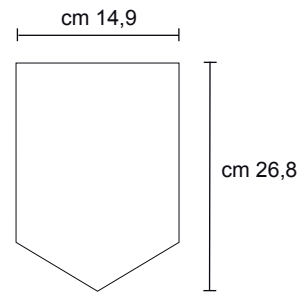
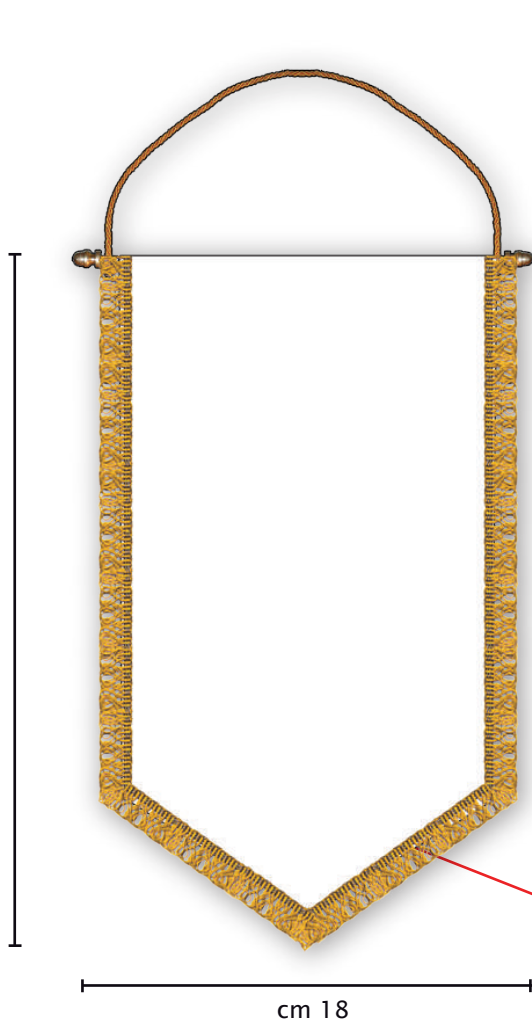

**AREA MASSIMA DI PERSONALIZZAZIONE:**  
la grafica dovrà essere inserita all'interno dell'area.

**MAXIMUM AREA FOR CUSTOMIZATION:**  
graphics should be included inside the lines.

**ZONE MAXIMALE DE MARQUAGE:**  
le graphique devra être inséré à l'intérieur de la zone.

**HÖCHSTFLÄCHE DER PERSONALISIERUNG:**  
die grafiken sollten die Grafik sollte.

### FRANGIA CORDONETTO

fringe  
frange  
franse



cm 1,5 (altezza)  
cm 1,5 (height)  
cm 1,5 (hauteur)  
cm 1,5 (höhe)

**Colori disponibili:**  
vedi pag. 63

Available colors :  
Couleurs disponibles : pag. 63  
Verfügen Farben :

### CORDINO - Ø mm 3

rope  
cordon  
Kordel



colore abbinato alla frangia  
color combined with the fringe  
couleur assortie à la frange  
farbe kombinierte die Fransen

**Colori disponibili:**  
vedi pag. 64

Available colors :  
Couleurs disponibles : pag. 64  
Verfügen Farben :

### BORCHIA - Ø mm 7

stud  
clou  
chef



Disponibile in OTTONE DORATO o OTTONE CROMATO

Available in golden or chrome brass  
Disponible en laiton doré ou chromé  
Verfügbar in gold oder Verchromt Messing

Material available :  
Matériel disponible :  
Material verfügbar :

#### Materiale disponibile

<b>raso</b> satin	
<b>raso Eco</b> cheap satin satin économique wirtschafts satin	<b>digitale</b> digital numérique
<b>raso turco</b> turkish satin satin turc satin türkisch	<b>ricamo</b> embroidery broderie stickerei

#### Tipologia di stampa

Type of printing  
Type d'impression  
Art der Druck

<b>digitale</b> digital numérique
<b>neutro</b> (interno cartoncino) neutral (internal cardboard) neutre (carton fin interne) neutral (Internal-Karte)

#### Imbottitura disponibile

available padding  
rembourrage disponible  
Polsterung verfügbar

<b>spugna</b> (sponge - éponge - schwamm)
<b>cartoncino</b> (cardboard - carton - karton)

#### Varianti di modello disponibili

Model's variants available  
Variantes de modèle disponibles  
Modellvarianten zur Verfügung

**C** - cm 16,5x27,5 (busta)  
**D** - cm 21x30 (busta)  
**E** - cm 16,5x27,5 + fiocco

pag.35

# MODELLO 5

cm 21x30 comprensivo di frangia

## Pentagonale con frangia, bacchetta, cordino, busta.

Pentagonal with rope, fringe envelope wand.

Pentagonal avec cordon, frange pochette baguette.

Fünfeck mit Kordel, Fransen Umschlag.

GAGLIARDETTI  
pennant  
fanion  
wimpel

cm 30

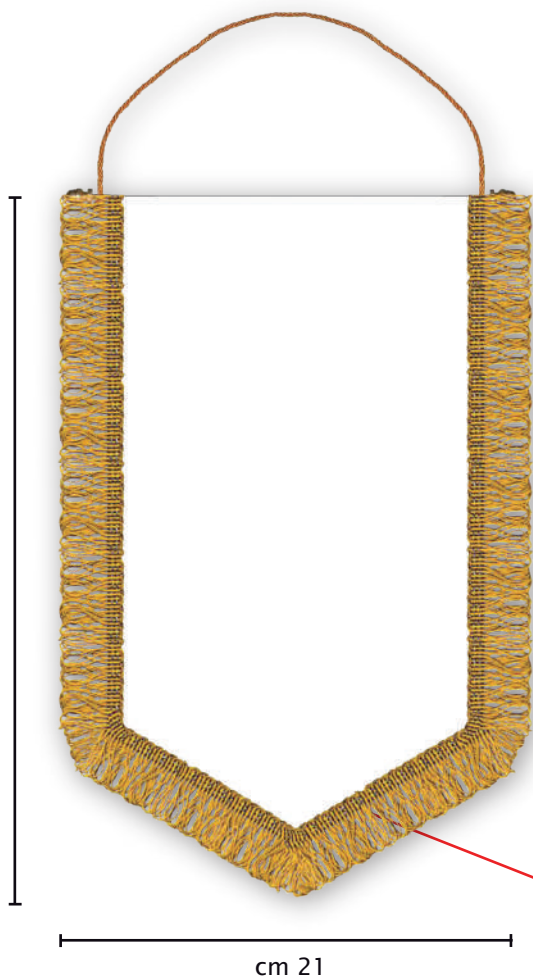

cm 21

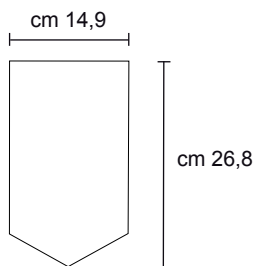

### AREA MASSIMA DI PERSONALIZZAZIONE:

la grafica dovrà essere inserita all'interno dell'area.

MAXIMUM AREA FOR CUSTOMIZATION:  
graphics should be included inside the lines.

ZONE MAXIMALE DE MARQUAGE:  
le graphique devra être inséré à l'intérieur de la zone.

HÖCHSTFLÄCHE DER PERSONALISIERUNG:  
die grafiken sollten die Grafik sollte.

### FRANGIA CORDONETTO

fringe  
frange  
franse

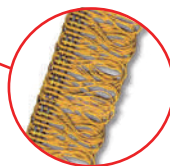

cm 3 (altezza)  
cm 3 (height)  
cm 3 (hauteur)  
cm 3 (höhe)

Colori disponibili:  
vedi pag. 63

Available colors :  
Couleurs disponibles : pag. 63  
Verfügen Farben :

### CORDINO - Ø mm 3

rope  
cordon  
Kordel



colore abbinato alla frangia  
color combined with the fringe  
couleur assortie à la frange  
farbe kombinierte die Fransen

Colori disponibili:  
vedi pag. 64

Available colors :  
Couleurs disponibles : pag.64  
Verfügen Farben :

### BORCHIA - Ø mm 7

stud  
clou  
chef



Disponibile in OTTONE DORATO o  
OTTONE CROMATO

Available in golden or chrome brass  
Disponible en laiton doré ou chromé  
Verfügbar in gold oder Verchromt Messing

Material available :  
Matériel disponible :  
Material verfügbar :

### Materiale disponibile

<b>raso</b> satin	
<b>raso Eco</b> cheap satin satin économique wirtschafts satin	<b>digitale</b> digital numérique
<b>raso turco</b> turkish satin satin turc satin türkisch	<b>ricamo</b> embroidery broderie stickerei

### Tipologia di stampa

Type of printing  
Type d'impression  
Art der Druck

<b>digitale</b> digital numérique
<b>neutro</b> (interno cartoncino) neutral (internal cardboard) neutre (carton fin interne) neutral (Internal-Karte)

### Imbottitura disponibile

available padding  
rembourrage disponible  
Polsterung verfügbar

<b>spugna</b> (sponge - éponge - schwamm)
<b>cartoncino</b> (cardboard - carton - karton)

### Varianti di modello disponibili

Model's variants available  
Variantes de modèle disponibles  
Modellvarianten zur verfügung

**C** - cm 16,5x27,5 (busta)  
**D** - cm 21x30 (busta)  
**E** - cm 16,5x27,5 + fiocco

pag.35



# MODELLO 15

cm 23,5x27,5 comprensivo di frangia

## Pentagonale con frangia, bacchetta, cordino, busta.

Pentagonal with rope  
wand, fringe envelope.

Pentagonale avec  
cor-don, frange,  
pochette, baguette.

Fünfeck mit Kordel, Fransen  
Umschlag.

GAGLIARDETTI  
pennant  
fanion  
wimpel

cm 27,5

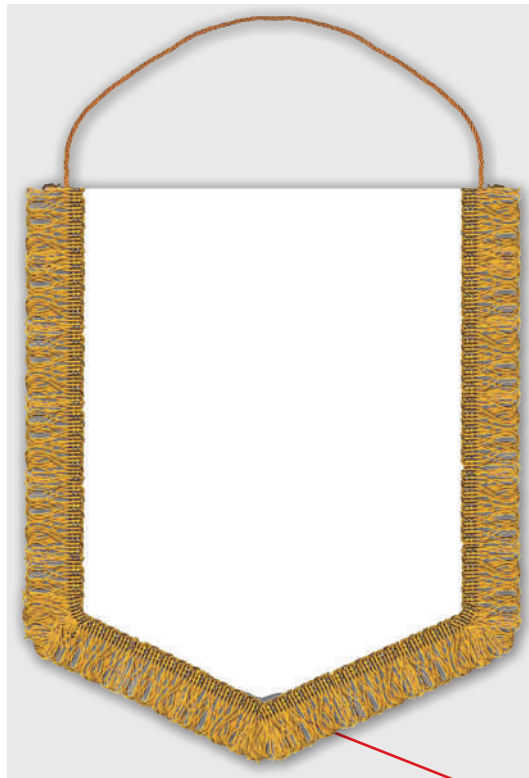

cm 23,5

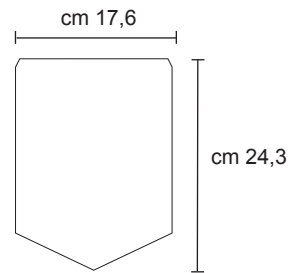

### AREA MASSIMA DI PERSONALIZZAZIONE:

la grafica dovrà essere inserita all'interno dell'area.

MAXIMUM AREA FOR CUSTOMIZATION:  
graphics should be included inside the lines.

ZONE MAXIMALE DE MARQUAGE:  
le graphique devra être inséré à l'intérieur de la zone.

HÖCHSTFLÄCHE DER PERSONALISIERUNG:  
die grafiken sollten die Grafik sollte.

### FRANGIA CORDONETTO

fringe  
frange  
franse

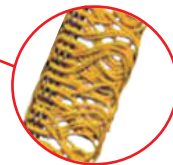

cm 3 (altezza)  
cm 3 (height)  
cm 3 (hauteur)  
cm 3 (höhe)

Colori disponibili:  
vedi pag. 63

Available colors :  
Couleurs disponibles : pag. 63  
Verfügen Farben :

### CORDINO - Ø mm 3

rope  
cordon  
Kordel



colore abbinato alla frangia  
color combined with the fringe  
couleur assortie à la frange  
farbe kombinierte die Fransen

Colori disponibili:  
vedi pag. 64

Available colors :  
Couleurs disponibles : pag. 64  
Verfügen Farben :

### BORCHIA - Ø mm 7

stud  
clou  
chef



Disponibile in OTTONE DORATO o  
OTTONE CROMATO

Available in golden or chrome brass  
Disponible en laiton doré ou chromé  
Verfügbar in gold oder Verchromt Messing

Material available :  
Matériel disponible :  
Material verfügbar :

### Materiale disponibile

<b>raso</b> satin	
<b>raso Eco</b> cheap satin satin économique wirtschafts satin	<b>digitale</b> digital numérique
<b>raso turco</b> turkish satin satin turc satin türkisch	<b>ricamo</b> embroidery broderie stickerei

### Tipologia di stampa

Type of printing  
Type d'impression  
Art der Druck

<b>digitale</b> digital numérique
<b>neutro</b> (interno cartoncino) neutral (internal cardboard) neutre (carton fin interne) neutral (Internal-Karte)

### Imbottitura disponibile

available padding  
rembourrage disponible  
Polsterung verfügbar

<b>spugna</b> (sponge - éponge - schwamm)
<b>cartoncino</b> (cardboard - carton - karton)

### Varianti di modello disponibili

Model's variants available  
Variantes de modèle disponibles  
Modellvarianten zur verfügung

- A - cm 18,5x25
- C - cm 19x25
- D - cm 23,5x27,5 (busta)
- E - cm 18,5x25 + fiocco
- F - cm 22x26
- G - cm 18,5x25  
(solo cucitura)

pag.35

# MODELLO 31

cm 20,5x29,5 comprensivo di frangia e passamaneria

## Pentagonale con passamaneria, frangia, bacchetta, cordino, busta.

Pentagonal with rope, trimmings, fringe envelope.

Pentagonale avec passementerie, frange, cordon, pochette.

Fünfeck mit Posament, Fransen, Kordel, Umschlag.

GAGLIARDETTI  
pennant  
fanion  
wimpel

cm 29,5

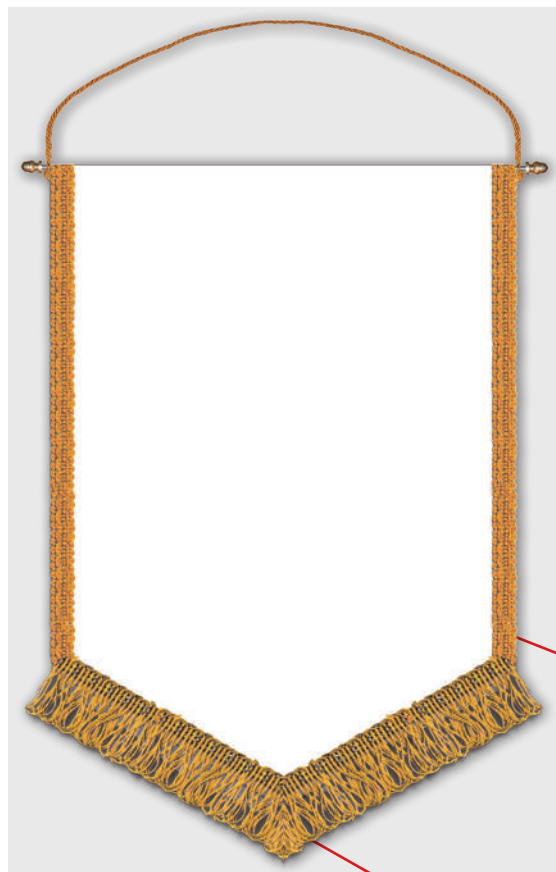

cm 20,5

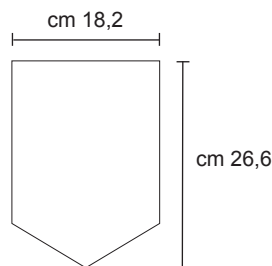

### AREA MASSIMA DI PERSONALIZZAZIONE:

la grafica dovrà essere inserita all'interno dell'area.

MAXIMUM AREA FOR CUSTOMIZATION:  
graphics should be included inside the lines.

SURFACE MAXIMALE DE MARQUAGE:  
le graphique devra être inséré à l'intérieur de la zone.

HÖCHSTFLÄCHE DER PERSONALISIERUNG:  
die grafiken sollten die Grafik sollte.

### PASSAMANERIA

trimmings  
passementerie  
Posament

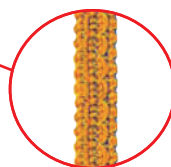

cm 1 (altezza)  
cm 1 (height)  
cm 1 (hauteur)  
cm 1 (höhe)

Colori disponibili:  
vedi pag. 63

Available colors :  
Couleurs disponibles : pag. 63  
Verfügen Farben :

### FRANGIA CORDONETTO

fringe  
frange  
franse

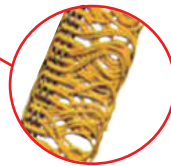

cm 3 (altezza)  
cm 3 (height)  
cm 3 (hauteur)  
cm 3 (höhe)

Colori disponibili:  
vedi pag. 63

Available colors :  
Couleurs disponibles : pag.63  
Verfügen Farben :

### CORDINO - Ø mm 3

rope  
cordon  
Kordel



colore abbinato alla frangia/passamaneria  
color combined with the fringe/trimmings  
couleur combiné la frange/passementerie  
farbe kombinierte die Fransen/verzierungen

Colori disponibili:  
vedi pag. 64

Available colors :  
Couleurs disponibles : pag. 64  
Verfügen Farben :

### BORCHIA - Ø mm 7

stud  
clou  
chef



Disponibile in OTTONE DORATO o OTTONE CROMATO

Available in golden or chrome brass  
Disponibile en laiton doré ou chromé  
Verfügar in gold oder Verchromt Messing

Material available :  
Matériel disponible :  
Material verfügbar :

### Materiale disponibile

### Tipologia di stampa

Type of printing  
Type d'impression  
Art der Druck

<b>raso</b> satin	<b>digitale</b> digital numérique
<b>raso Eco</b> cheap satin satin économique wirtschafts satin	<b>neutro</b> (interno cartoncino) neutral (internal cardboard) neutre (carte interne) neutral (Internal-Karte)
<b>raso turco</b> turkish satin satin turc satin türkisch	<b>digitale</b> digital numérique
	<b>ricamo</b> embroidery broderie stickerei

### Imbottitura disponibile

available padding  
rembourrage disponibles  
Polsterung verfügbar

**spugna** (sponge - éponge - schwamm)  
**cartoncino** (cardboard - carton - karton)

### Varianti di modello disponibili

Model's variants available  
Variantes de modèle disponibles  
Modellvarianten zur verfügung



# MODELLO 7

cm 20,5x27,5 comprensivo di  
passamaneria - escluso fiocco -

## Pentagonale con passamaneria, fiocco, bacchetta, cordino, senza busta.

Pentagonal with rope, trimmings, tassel, without envelope. : Pentagonal avec pas- sementerie, pompon, baguette, cordon, sans pochette. : Fünfeckig mit Posament, Bausch, Stab, Krodol, otine Umschlag

GAGLIARDETTI  
pennant  
fanion  
wimpel

cm 27,5

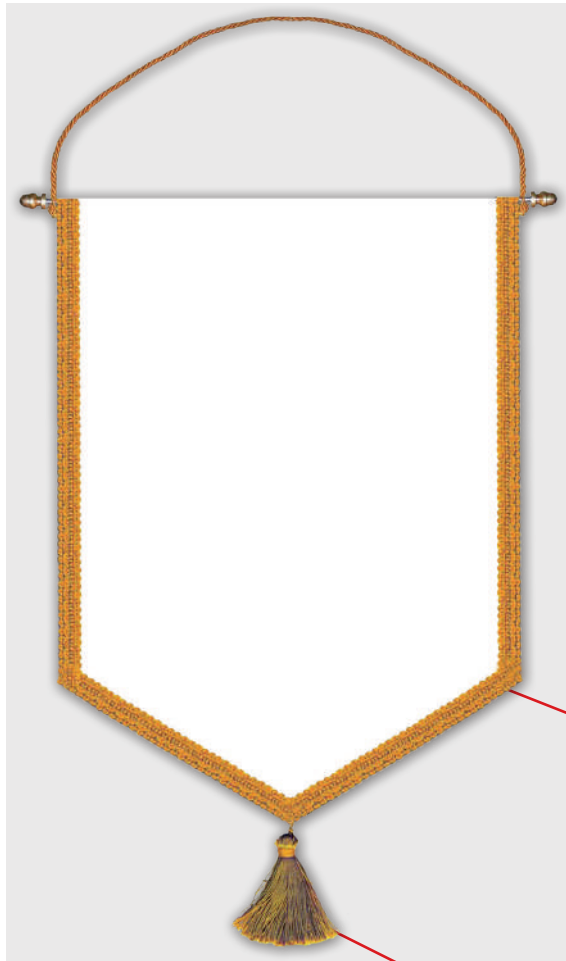

cm 20,5

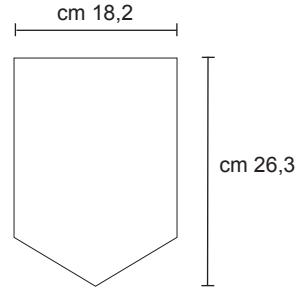

### AREA MASSIMA DI PERSONALIZZAZIONE:

la grafica dovrà essere inserita all'interno dell'area.

MAXIMUM AREA FOR CUSTOMIZATION:  
graphics should be included inside the lines.

ZONE MAXIMALE DE MARQUAGE:  
le graphique devra être inséré à l'intérieur de la zone.

HÖCHSTFLÄCHE DER PERSONALISIERUNG:  
die grafiken sollten die Grafik sollte.

### PASSAMANERIA

trimmings  
passementerie  
Posament

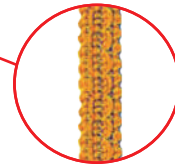

cm 1 (altezza)  
cm 1 (height)  
cm 1 (hauteur)  
cm 1 (höhe)

Colori disponibili:  
vedi pag. 63

Available colors :  
Couleurs disponibles : pag. 63  
Verfügen Farben :

### FIOCCO cm 5

tassel  
pompon  
bogen



colore abbinato alla passamaneria  
color combined with the trimmings  
couleur assortie à la passementerie  
farbe kombinierte die Verzierungen

Colori disponibili:  
vedi pag. 63

Available colors :  
Couleurs disponibles : pag. 63  
Verfügen Farben :

### CORDINO - Ø mm 3

rope  
cordon  
Kordel



colore abbinato alla passamaneria  
color combined with the trimmings  
couleur assortie à la passementerie  
farbe kombinierte die Verzierungen

Colori disponibili:  
vedi pag. 64

Available colors :  
Couleurs disponibles : pag. 64  
Verfügen Farben :

### BORCHIA - Ø mm 7

stud  
clou  
chef



Disponibile in OTTONE DORATO o  
OTTONE CROMATO

Available in golden or chrome brass  
Disponibile en laiton doré ou chromé  
Verfügbar in gold oder Verchromt Messing

Material available :  
Matériel disponible :  
Material verfügbar :

### Materiale disponibile

<b>raso</b> satin	
<b>raso Eco</b> cheap satin satin économique wirtschafts satin	<b>digitale</b> digitale numérique
<b>raso turco</b> turkish satin satin turc satin türkisch	<b>ricamo</b> embroidery broderie stickerei

### Tipologia di stampa

Type of printing  
Type d'impression  
Art der Druck

<b>digitale</b> digitale numérique	
<b>neutro</b> (interno cartoncino) neutral (internal cardboard) neutre (carton fin interne) neutral (Internal-Karte)	

### Imbottitura disponibile

available padding  
rembourrage disponible  
Polsterung verfügbar

<b>spugna</b> (sponge - éponge - schwamm)	
<b>cartoncino</b> (cardboard - carton - karton)	

### Varianti di modello disponibili

Model's variants available  
Variantes de modèle disponibles  
Modellvarianten zur verfügung

- A - cm 20,5x27,5
- B - cm 25x30
- C - cm 21x28
- D - cm 25x30
- E - cm 20,5x27,5 + fiocco
- F - cm 21x28,5 (busta)
- G - cm 20,5x27,5 (solo cucitura)

pag.35





# MODELLO 10

cm 24x31 comprensivo di frangia

## Pentagonale con frangia, bacchetta, cordino, busta.

Pentagonal with rope, fringe envelope wand.

Pentagonal avec cordon, frange pochette baguette.

Fünfeck mit Kordel, Fransen Umschlag.

GAGLIARDETTI  
pennant  
fanion  
wimpel

cm 31

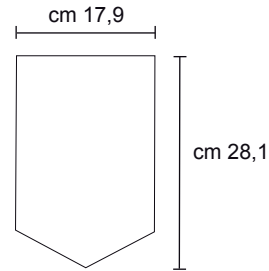
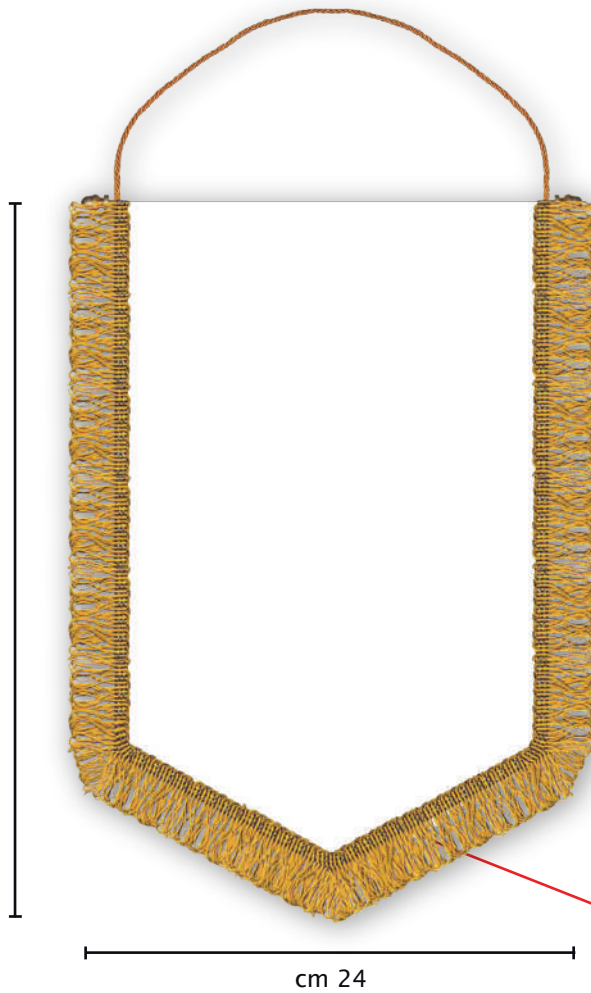

### AREA MASSIMA DI PERSONALIZZAZIONE:

la grafica dovrà essere inserita all'interno dell'area.

### MAXIMUM AREA FOR CUSTOMIZATION:

graphics should be included inside the lines.

### ZONE MAXIMALE DE MARQUAGE:

le graphique devra être inséré à l'intérieur de la zone.

### HÖCHSTFLÄCHE DER PERSONALISIERUNG:

die grafiken sollten die Grafik sollte.

### FRANGIA CORDONETTO

fringe  
frange  
franse

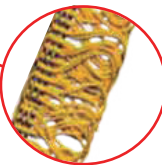

cm 3 (altezza)  
cm 3 (height)  
cm 3 (hauteur)  
cm 3 (höhe)

Colori disponibili:  
vedi pag. 63

Available colors :  
Couleurs disponibles : pag. 63  
Verfügen Farben :

### CORDINO - Ø mm 3

rope  
cordon  
Kordel



colore abbinato alla frangia  
color combined with the fringe  
couleur assortie à la frange  
farbe kombinierte die Fransen

Colori disponibili:  
vedi pag. 64

Available colors :  
Couleurs disponibles : pag. 64  
Verfügen Farben :

### BORCHIA - Ø mm 7

stud  
clou  
chef



Disponibile in OTTONE DORATO o OTTONE CROMATO

Available in golden or chrome brass  
Disponible en laiton doré ou chromé  
Verfügar in gold oder Verchromt Messing

Material available :  
Matériel disponible :  
Material verfügbar :

### Materiale disponibile

### Tipologia di stampa

Type of printing  
Type d'impression  
Art der Druck

<b>raso</b> satin	<b>digitale</b> digital numérique
<b>raso Eco</b> cheap satin satin économique wirtschafts satin	<b>neutro (interno cartoncino)</b> neutral (internal cardboard) neutre (carton fin interne) neutral (Internal-Karte)
<b>raso turco</b> turkish satin satin turc satin türkisch	<b>digitale</b> digital numérique
	<b>ricamo</b> embroidery broderie stickerei

### Imbottitura disponibile

available padding  
rembourrage disponible  
Polsterung verfügbar

**spugna** (sponge - éponge - schwamm)  
**cartoncino** (cardboard - carton - karton)

### Varianti di modello disponibili

Model's variants available  
Variantes de modèle disponibles  
Modellvarianten zur verfügung

A - cm 19x29,5 (busta)  
C - cm 19,5x30 (busta)  
D - cm 24x31 (busta)  
E - cm 19x29,5 + fiocco  
F - cm 21x30,5 (busta)  
G - cm 19x29,5 (solo cucitura)

pag.35



# MODELLO 45

cm 23x34,5 comprensivo di frangia

## Pentagonale con frangia, bacchetta, cordino, busta (adattata + larga)

Pentagonal with rope, fringe envelope wand.

Pentagonal avec cordon, frange, pochette, baguette.

Fünfeck mit Kordel, Fransen Umschlag.

GAGLIARDETTI  
pennant  
fanion  
wimpel

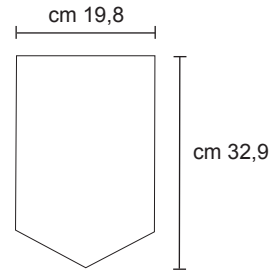
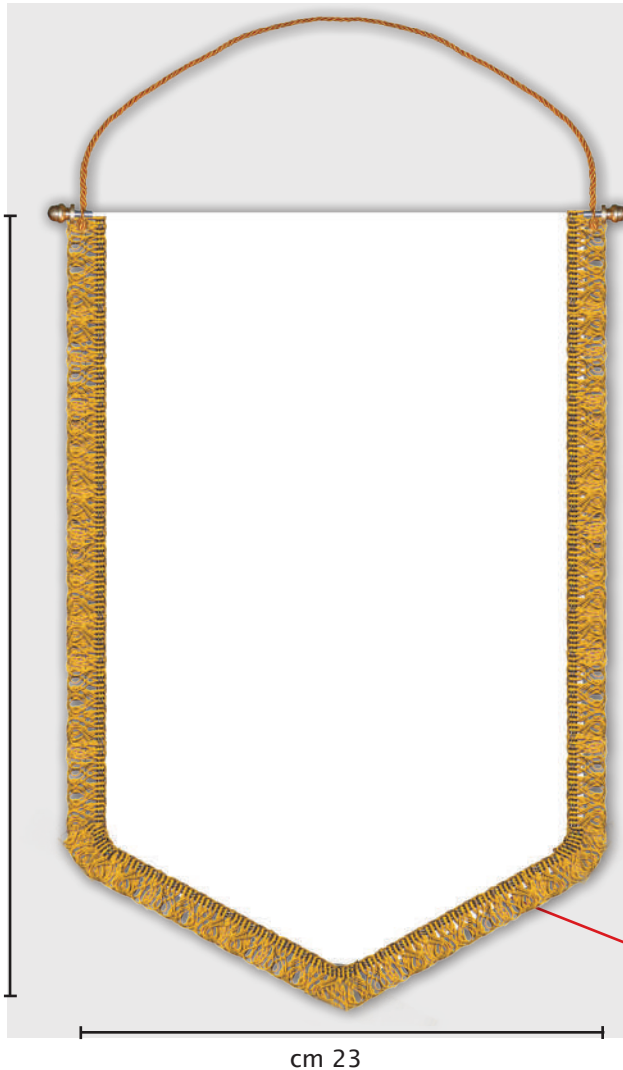

### AREA MASSIMA DI PERSONALIZZAZIONE:

la grafica dovrà essere inserita all'interno dell'area.

### MAXIMUM AREA FOR CUSTOMIZATION:

graphics should be included inside the lines.

### ZONE MAXIMALE DE MARQUAGE:

le graphique devra être inséré à l'intérieur de la zone.

### HÖCHSTFLÄCHE DER PERSONALISIERUNG:

die grafiken sollten die Grafik sollte.

### FRANGIA CORDONETTO

fringe  
frange  
franse



cm 1,5 (altezza)  
cm 1,5 (height)  
cm 1,5 (hauteur)  
cm 1,5 (höhe)

Colori disponibili:  
vedi pag. 63

Available colors :  
Couleurs disponibles : pag.63  
Verfügen Farben :

### CORDINO - Ø mm 3

rope  
cordon  
Kordel



colore abbinato alla frangia  
color combined with the fringe  
couleur assortie à la frange  
farbe kombinierte die Fransen

Colori disponibili:  
vedi pag. 64

Available colors :  
Couleurs disponibles : pag. 64  
Verfügen Farben :

### BORCHIA - Ø mm 9

stud  
clou  
chef



Disponibile in OTTONE DORATO o OTTONE CROMATO

Available in golden or chrome brass  
Disponible en laiton doré ou chromé  
Verfügbar in gold oder Verchromt Messing

Material available :  
Matériel disponible :  
Material verfügbar :

### Materiale disponibile

<b>raso</b> satin	
<b>raso Eco</b> cheap satin satin économique wirtschafts satin	<b>digitale</b> digital numérique
<b>raso turco</b> turkish satin satin turc satin türkisch	<b>ricamo</b> embroidery broderie stickerei

### Imbottitura disponibile

available padding  
rembourrage disponible  
Polsterung verfügbar

<b>spugna</b> (sponge - éponge - schwamm)	
<b>cartoncino</b> (cardboard - carton - karton)	

### Varianti di modello disponibili

Model's variants available  
Variantes de modèle disponibles  
Modellvarianten zur verfügung

**A** - cm 21,5x33,5  
**C** - cm 21,5x34  
**D** - cm 26x36 (busta)  
**E** - cm 21x33,5 + fiocco  
**G** - cm 21x33,5  
(solo cucitura)

pag.35

# MODELLO 4

cm 26x36 comprensivo di frangia

## Pentagonale con frangia, bacchetta, cordino, busta.

Pentagonal with rope, fringe envelope wand.

Pentagonal avec cordon, frange, pochette, baguette.

Fünfeck mit Kordel, Fransen Umschlag.



GAGLIARDETTI  
pennant  
fanion  
wimpel

cm 36

cm 26

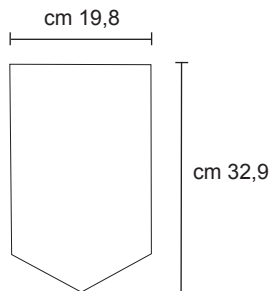

### AREA MASSIMA DI PERSONALIZZAZIONE:

la grafica dovrà essere inserita all'interno dell'area.

MAXIMUM AREA FOR CUSTOMIZATION:  
graphics should be included inside the lines.

ZONE MAXIMALE DE MARQUAGE:  
le graphique devra être inséré à l'intérieur de la zone.

HÖCHSTFLÄCHE DER PERSONALISIERUNG:  
die grafiken sollten die Grafik sollte.

### FRANGIA CORDONETTO

fringe  
frange  
franse



cm 3 (altezza)  
cm 3 (height)  
cm 3 (hauteur)  
cm 3 (höhe)

Colori disponibili:  
vedi pag. 63

Available colors :  
Couleurs disponibles : pag. 63  
Verfügen Farben :

### CORDINO - Ø mm 3

rope  
cordon  
Kordel



colore abbinato alla frangia  
color combined with the fringe  
couleur assortie à la frange  
farbe kombinierte die Fransen

Colori disponibili:  
vedi pag. 64

Available colors :  
Couleurs disponibles : pag. 64  
Verfügen Farben :

### BORCHIA - Ø mm 9

stud  
clou  
chef



Disponibile in OTTONE DORATO o  
OTTONE CROMATO

Available in golden or chrome brass  
Disponible en laiton doré ou chromé  
Verfügbar in gold oder Verchromt Messing

Material available :  
Matériel disponible : **Materiale disponibile**  
Material verfügbar :

Tipologia di stampa :  
Type of printing :  
Type d'impression :  
Art der Druck :

<b>raso</b> satin	<b>digitale</b> digital numérique
<b>raso Eco</b> cheap satin satin économique wirtschafts satin	<b>neutro</b> (interno cartoncino) neutral (internal cardboard) neutre (carton fin interne) neutral (Internal-Karte)
<b>raso turco</b> turkish satin satin turc satin türkisch	<b>digitale</b> digital numérique
	<b>ricamo</b> embroidery broderie stickerei

**Imbottitura disponibile** : available padding  
: rembourrage disponible  
: Polsterung verfügbar

**spugna** (sponge - éponge - schwamm)  
**cartoncino** (cardboard - carton - karton)

### Varianti di modello disponibili

Model's variants available  
Variantes de modèle disponibles  
Modellvarianten zur verfügung

**A** - cm 21x33,5  
**C** - cm 21,5x34  
**D** - cm 26x36 (busta)  
**E** - cm 21x33,5 + fiocco  
**G** - cm 21x33,5  
(solo cucitura)

pag.35



### VARIANTE A

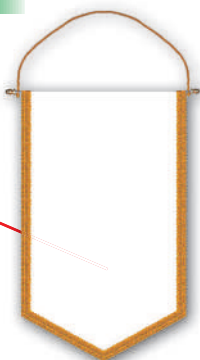
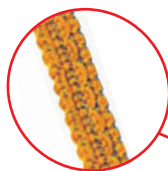

#### Pentagonale con passamaneria (cm 1).

Pentagonal with trimming.

Pentagonale avec passemanerie.

Fünfeckig mit Posament.

**Colori disponibili:** Available colors  
vedi pag. 63 Couleurs disponibles  
Verfügen Farben

pag. 63

### VARIANTE B

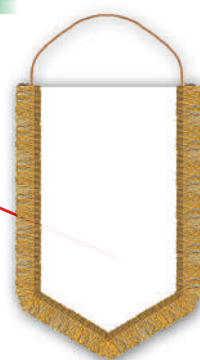

#### Pentagonale con frangia cordonetto (cm 3).

Pentagonal with fringe.

Pentagonale avec une frange.

Fünfeckig mit Fransen.

**Colori disponibili:** Available colors  
vedi pag. 63 Couleurs disponibles  
Verfügen Farben

pag. 63

### VARIANTE C

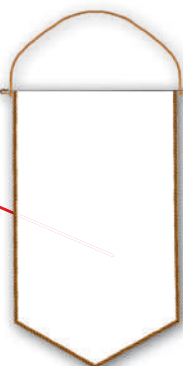

#### Pentagonale con cordino perimetrale (Ø 4 mm).

Pentagonal with perimetric rope.

Pentagonale avec cordon périmétral.

Fünfeckig mit Lanyard Umfang.

**Colori disponibili:** Available colors  
vedi pag. 64 Couleurs disponibles  
Verfügen Farben

pag. 64

### VARIANTE D



#### Pentagonale con frangia tripolino (cm 3).

Pentagonal with Tripoli.

Pentagonale avec Tripoli.

Fünfeckig mit Tripolis.

**Colori disponibili:** Available colors  
vedi pag. 63 Couleurs disponibles  
Verfügen Farben

pag. 63

### VARIANTE E



#### Pentagonale solo cucitura con fiocco (cm 5).

Pentagonal only sewn with tassel

Pentagonale couture avec pompon

Fünfeckig nur Naht mit Schleife.

**Colori disponibili:** Available colors  
vedi pag. 63 Couleurs disponibles  
Verfügen Farben

pag. 63

### VARIANTE F

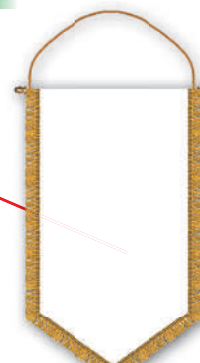

#### Pentagonale con frangia cordonetto (cm 1,5).

Pentagonal with fringe.

Pentagonale avec une frange.

Fünfeckig mit Fransen.

**Colori disponibili:** Available colors  
vedi pag. 63 Couleurs disponibles  
Verfügen Farben

pag. 63

#### N.B.

Cordino e bacchetta, ove previsti, non variano rispetto al modello scelto.

La presenza della busta è specificata dalla variante del modello scelto.

Rope and wand, if provided, do not vary compared to the model chosen. The presence of the envelope is specified by the type of the chosen model.

Cordon et baguette, si fournis, ne varient pas par rapport au modèle choisi. La présence de la pochette est définie par la typologie du modèle choisi.

Kordel und Stab, wenn verfügbar, variieren sie nicht in bezug auf das gewählte Modell.

# MODELLO 24

cm 15,5x21 comprensivo di frangia

## Rettangolare con frangia, bacchetta, cordino, senza busta.

Rectangular with rope, fringe, wand, without envelope. : Rectangulaire avec frange, cordon, baguette, sans pochette. : Rechteckig mit Fransen, ohne Umschläge.

GAGLIARDETTI  
pennant  
fanion  
wimpel

cm 21

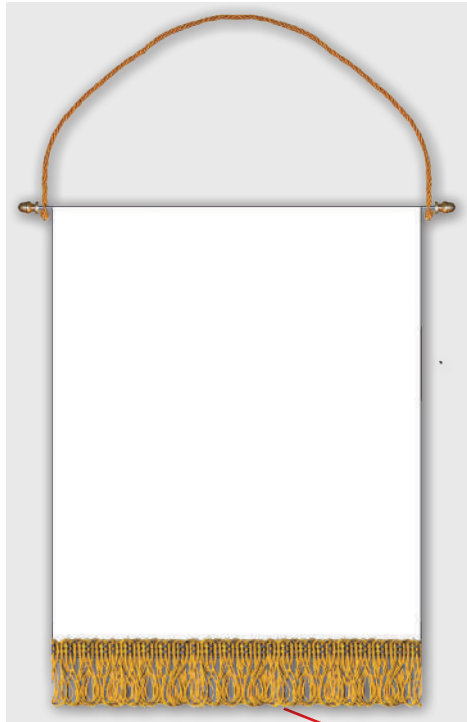

cm 15,5

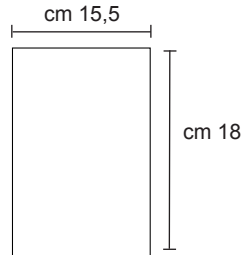

**AREA MASSIMA DI PERSONALIZZAZIONE:**  
la grafica dovrà essere inserita all'interno dell'area.

**MAXIMUM AREA FOR CUSTOMIZATION:**  
graphics should be included inside the lines.

**ZONE MAXIMALE DE MARQUAGE:**  
le graphique devra être inséré à l'intérieur de la zone.

**HÖCHSTFLÄCHE DER PERSONALISIERUNG:**  
die grafiken sollten die Grafik sollte.

### FRANGIA CORDONETTO

fringe  
frange  
franse

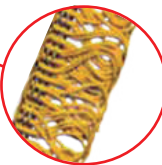

cm 3 (altezza)  
cm 3 (height)  
cm 3 (hauteur)  
cm 3 (höhe)

**Colori disponibili:**  
vedi pag. 63

Available colors :  
Couleurs disponibles : pag. 63  
Verfügen Farben :

### CORDINO - Ø mm 3

rope  
cordon  
Kordel



colore abbinato alla frangia  
color combined with the fringe  
couleur assortie à la frange  
farbe kombinierte die Fransen

**Colori disponibili:**  
vedi pag. 64

Available colors :  
Couleurs disponibles : pag. 64  
Verfügen Farben :

### BORCHIA - Ø mm 7

stud  
clou  
chef



Disponibile in OTTONE DORATO o OTTONE CROMATO

Available in golden or chrome brass  
Disponible en laiton doré ou chromé  
Verfügbar in gold oder Verchromt Messing

Material available :  
Matériel disponible :  
Material verfügbar :

**Materiale disponibile**

Tipologia di stampa : Type of printing  
Type d'impression  
Art der Druck

<b>raso</b> satin	<b>digitale</b> digital numérique
<b>raso Eco</b> cheap satin satin économique wirtschafts satin	<b>digitale</b> digital numérique
<b>raso turco</b> turkish satin satin turc satin türkisch	<b>ricamo</b> embroidery broderie stickerei
	<b>neutro</b> (interno cartoncino) neutral (internal cardboard) neutre (carton fin interne) neutral (Internal-Karte)

**Imbottitura disponibile** : available padding  
rembourrage disponible  
Polsterung verfügbar

**cartoncino** (cardboard - carton - karton)

**Varianti di modello disponibili**

Model's variants available  
Variantes modèle disponibles  
Modellvarianten zur verfügung

- A - cm 15,5x19
- B - cm 20x20,5
- C - cm 16,5x19
- D - cm 20x20,5
- E - cm 15,5x18,5 + fiocco
- F - cm 17x19
- G - cm 15,5x18,5 (solo cucitura)

pag.45



# MODELLO 25

cm 21x19,5 comprensivo di frangia

## Rettangolare con frangia, bacchetta, cordino, senza busta.

Rectangular with rope, fringe, wand, without envelope. : Rectangulaire avec frange, cordon, baguette, sans pochette. : Rechteckig mit Fransen, ohne Umschläge.

GAGLIARDETTI  
pennant  
fanion  
wimpel

cm 19,5

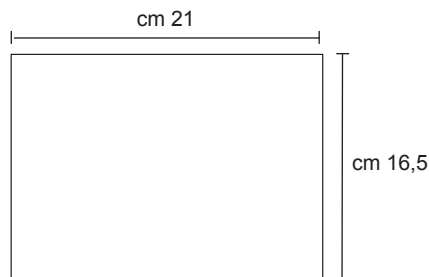
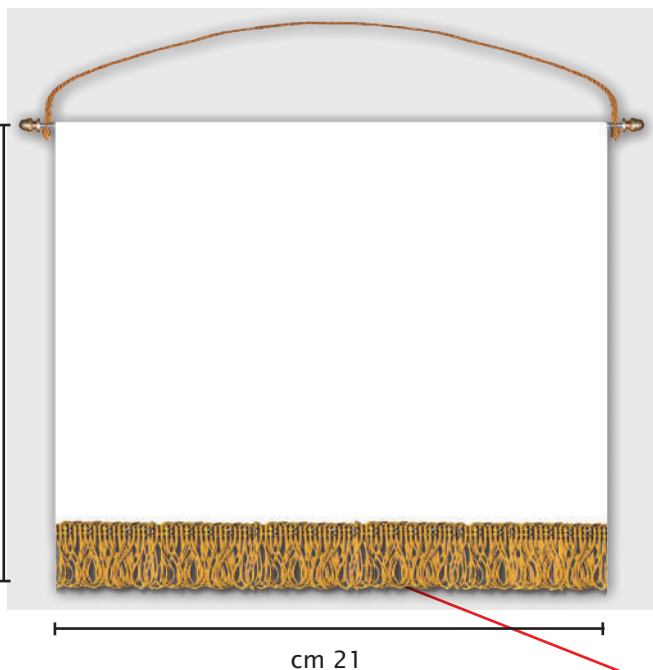

### AREA MASSIMA DI PERSONALIZZAZIONE:

la grafica dovrà essere inserita all'interno dell'area.

MAXIMUM AREA FOR CUSTOMIZATION:  
graphics should be included inside the lines.

ZONE MAXIMALE DE MARQUAGE:  
le graphique devra être inséré à l'intérieur de la zone.

HÖCHSTFLÄCHE DER PERSONALISIERUNG:  
die grafiken sollten die Grafik sollte.

### FRANGIA CORDONETTO

fringe  
frange  
franse



cm 3 (altezza)  
cm 3 (height)  
cm 3 (hauteur)  
cm 3 (höhe)

Colori disponibili:  
vedi pag. 63

Available colors :  
Couleurs disponibles : pag. 63  
Verfügen Farben :

### CORDINO - Ø mm 3

rope  
cordon  
Kordel



colore abbinato alla frangia  
color combined with the fringe  
couleur assortie à la frange  
farbe kombinierte die Fransen

Colori disponibili:  
vedi pag. 64

Available colors :  
Couleurs disponibles : pag. 64  
Verfügen Farben :

### BORCHIA - Ø mm 7

stud  
clou  
chef



Disponibile in OTTONE DORATO o OTTONE CROMATO

Available in golden or chrome brass  
Disponible en laiton doré ou chromé  
Verfügbar in gold oder Verchromt Messing

Material available :  
Matériel disponible :  
Material verfügbar :

### Materiale disponibile

	Tipologia di stampa	Type of printing Type d'impression Art der Druck
<b>raso</b> satin	<b>digitale</b> digital numérique	
	<b>neutro</b> (interno cartoncino) neutre (carton fin interne) neutral (Internal-Karte)	
<b>raso Eco</b> cheap satin satin économique wirtschafts satin	<b>digitale</b> digital numérique	
<b>raso turco</b> turkish satin satin turc satin türkisch	<b>ricamo</b> embroidery broderie stickerei	

### Imbottitura disponibile

available padding  
rembourrage disponible  
Polsterung verfügbar

**cartoncino** (cardboard - carton - karton)

### Varianti di modello disponibili

Model's variants available  
Variantes modèle disponibles  
Modellvarianten zur Verfügung

A - cm 21x17,5  
B - cm 25,5x19  
C - cm 22x17,5  
D - cm 25,5x19  
E - cm 21x17 + fiocco  
F - cm 22,5x17,5  
G - cm 21x17  
(solo cucitura)

pag.45

# MODELLO 26

cm 18x27 comprensivo di frangia

## Rettangolare con frangia, bacchetta, cordino, senza busta.

Rectangular with rope, fringed, wand, without envelope. : Rectangulaire avec frange, cordon, baguette, sans pochette. : Rechteckig mit Fransen, ohne Umschläge.

GAGLIARDETTI  
pennant  
fanion  
wimpel

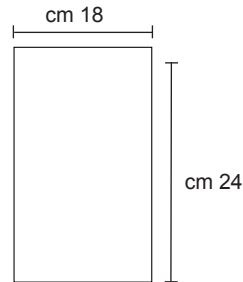
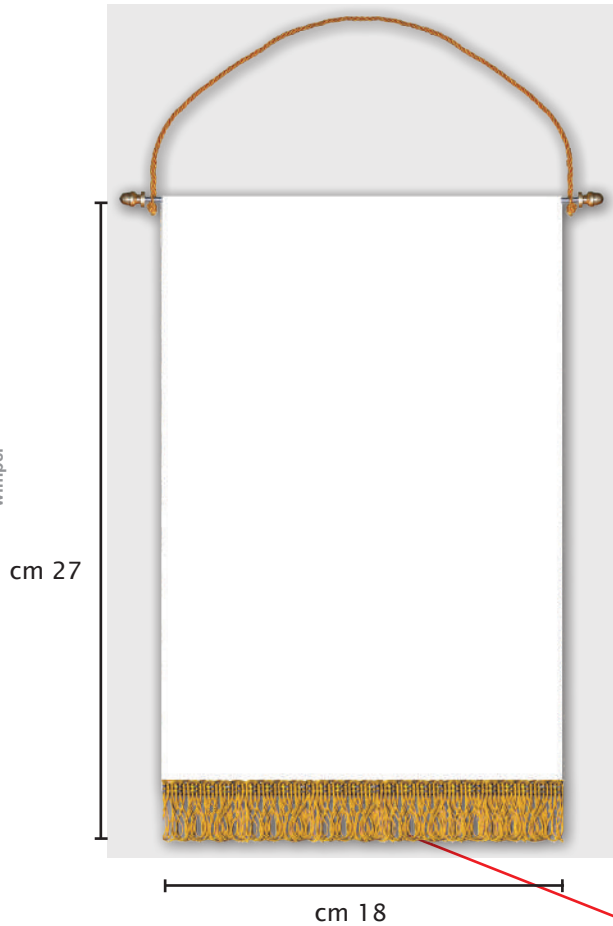

**AREA MASSIMA DI PERSONALIZZAZIONE:**  
la grafica dovrà essere inserita all'interno dell'area.

**MAXIMUM AREA FOR CUSTOMIZATION:**  
graphics should be included inside the lines.

**ZONE MAXIMALE DE MARQUAGE:**  
le graphique devra être inséré à l'intérieur de la zone.

**HÖCHSTFLÄCHE DER PERSONALISIERUNG:**  
die grafiken sollten die Grafik sollte.

### FRANGIA CORDONETTO

fringe  
frange  
franse

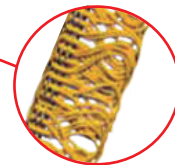

cm 3 (altezza)  
cm 3 (height)  
cm 3 (hauteur)  
cm 3 (höhe)

**Colori disponibili:**  
vedi pag. 63

Available colors :  
Couleurs disponibles : pag. 63  
Verfügen Farben :

### CORDINO - Ø mm 3

rope  
cordon  
Kordel



colore abbinato alla frangia  
color combined with the fringe  
couleur assortie à la frange  
farbe kombinierte die Fransen

**Colori disponibili:**  
vedi pag. 64

Available colors :  
Couleurs disponibles : pag. 64  
Verfügen Farben :

### BORCHIA - Ø mm 7

stud  
clou  
chef



Disponibile in OTTONE DORATO o OTTONE CROMATO

Available in golden or chrome brass  
Disponible en laiton doré ou chromé  
Verfügbar in gold oder Verchromt Messing

Material available :  
Matériel disponible : **Materiale disponibile**  
Material verfügbar :

Tipologia di stampa : Type of printing  
Type d'impression  
Art der Druck

<b>raso</b> satin	<b>digitale</b> digital numérique
<b>raso Eco</b> cheap satin satin économique wirtschafts satin	<b>neutro</b> (interno cartoncino) neutral (internal cardboard) neutre (carton fin interne) neutral (Internal-Karte)
<b>raso turco</b> turkish satin satin turc satin türkisch	<b>digitale</b> digital numérique
	<b>ricamo</b> embroidery broderie stickerei

**Imbottitura disponibile** : available padding  
rembourrage disponible  
Polsterung verfügbar

**cartoncino** (cardboard - carton - karton)

**Varianti di modello disponibili**  
Model's variants available  
Variantes modèle disponibles  
Modellvarianten zur verfügung

- A - cm 18x25
- B - cm 22,5x26,5
- C - cm 19x25 (busta)
- D - cm 22,5x26,5
- E - cm 18x24,5 + fiocco
- F - cm 19,5x25
- G - cm 18x24,5 (solo cucitura)

pag.45



# MODELLO 32

cm 18,5x25 comprensivo di passamaneria

## Rettangolare con passamaneria, bacchetta, cordino, busta.

Rectangular with rope, trimmings, wand, envelope.

Rectangulaire avec passementerie, cordon, baguette, pochette.

Rechteckig mit Posament, Stab, Umschläge.

GAGLIARDETTI  
pennant  
fanion  
wimpel

cm 25

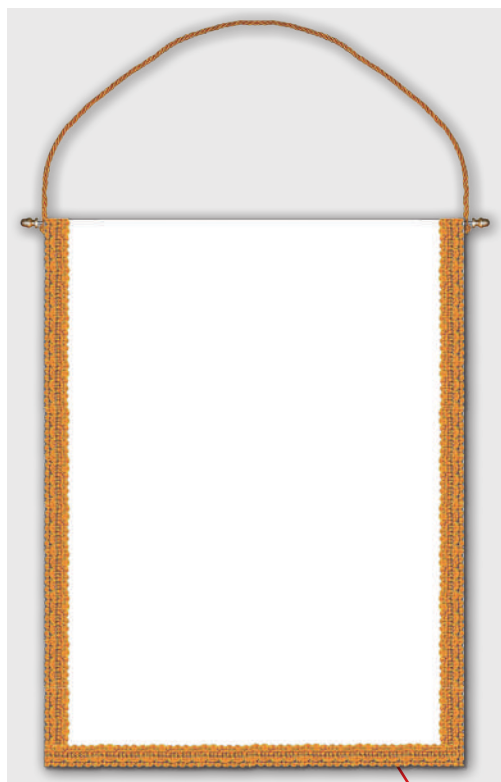

cm 18,5

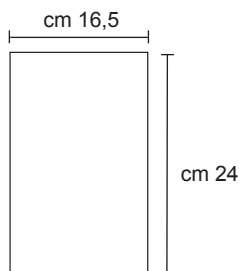

### AREA MASSIMA DI PERSONALIZZAZIONE:

la grafica dovrà essere inserita all'interno dell'area.

MAXIMUM AREA FOR CUSTOMIZATION:  
graphics should be included inside the lines.

ZONE MAXIMALE DE MARQUAGE:  
le graphique devra être inséré à l'intérieur de la zone.

HÖCHSTFLÄCHE DER PERSONALISIERUNG:  
die grafiken sollten die Grafik sollte.

Material available :  
Matériel disponible :  
Material verfügbar :

**Materiale disponibile**

**Tipologia di stampa**

Type of printing :  
Type d'impression :  
Art der Druck :

<b>raso satin</b>	<b>digitale</b> digital numérique <b>neutro</b> (interno cartoncino) neutral (internal cardboard) neutre (carton fin interne) neutral (Internal-Karte)
<b>raso Eco</b> cheap satin satin économique wirtschafts satin	<b>digitale</b> digital numérique
<b>raso turco</b> turkish satin satin turc satin türkisch	<b>ricamo</b> embroidery broderie stickerei

**Imbottitura disponibile**

available padding  
rembourrage disponible  
Polsterung verfügbar

**cartoncino** (cardboard - carton - karton)

**Varianti di modello disponibili**

Model's variants available  
Variantes modèle disponibles  
Modellvarianten zur verfügung

- B** - cm 22,5x27
- C** - cm 18,5x25 (busta)
- D** - cm 22,5x27
- E** - cm 18x24,5 + fiocco
- F** - cm 19,5x25,5
- G** - cm 18x24,5 (busta) (solo cucitura)

pag.45

### PASSAMANERIA

trimmings  
passementerie  
Posament

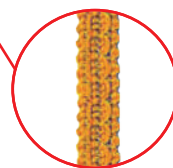

cm 1 (altezza)  
cm 1 (height)  
cm 1 (hauteur)  
cm 1 (höhe)

**Colori disponibili:**  
vedi pag. 63

Available colors :  
Couleurs disponibles : pag. 63  
Verfügen Farben :

### CORDINO - Ø mm 3

rope  
cordon  
Kordel



colore abbinato alla passamaneria  
color combined with the trimmings  
couleur assortie à la passementerie  
farbe kombinierte die Verzierungen

**Colori disponibili:**  
vedi pag. 64

Available colors :  
Couleurs disponibles : pag. 64  
Verfügen Farben :

### BORCHIA - Ø mm 7

stud  
clou  
chef



Disponibile in OTTONE DORATO o OTTONE CROMATO

Available in golden or chrome brass  
Disponible en laiton doré ou chromé  
Verfügbar in gold oder Verchromt Messing





# MODELLO 35

cm 19x25,5 comprensivo di passamaneria e frangia

## Rettangolare con passamaneria, frangia, bacchetta, cordino, busta.

Rectangular with rope, fringe, trimmings, wand, envelope. : Rectangulaire avec frange, passementerie, cordon, baguette, pochette. : Rechteckig mit Posament, Fransen, Stab, Umschläge.

GAGLIARDETTI  
pennant  
fanion  
wimpel

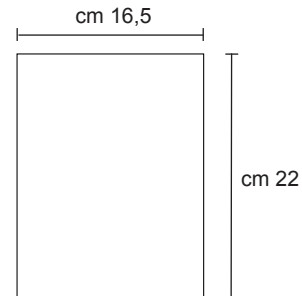
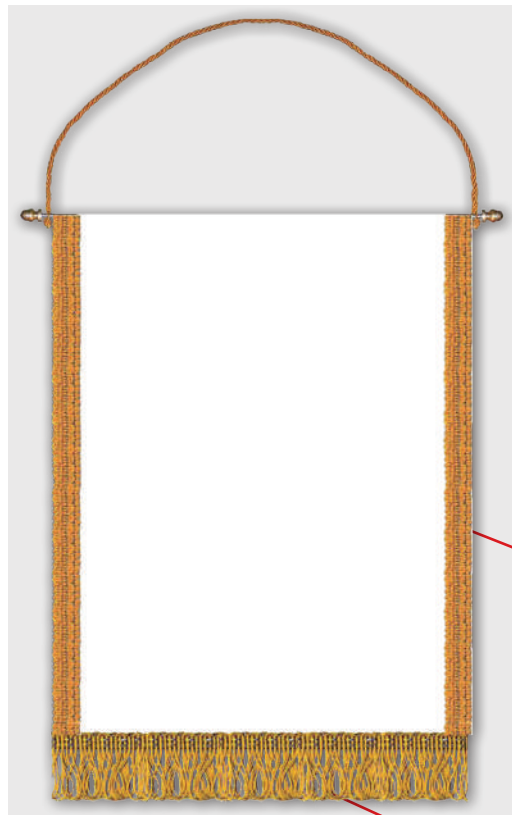

**AREA MASSIMA DI PERSONALIZZAZIONE:**  
la grafica dovrà essere inserita all'interno dell'area.

**MAXIMUM AREA FOR CUSTOMIZATION:**  
graphics should be included inside the lines.

**SURFACE MAXIMALE DE MARQUAGE:**  
le graphique devra être inséré à l'intérieur de la zone.

**HÖCHSTFLÄCHE DER PERSONALISIERUNG:**  
die grafiken sollten die Grafik sollte.

cm 25,5

cm 19

### PASSAMANERIA

trimmings  
passementerie  
Posament

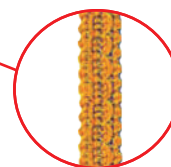

cm 1 (altezza)  
cm 1 (height)  
cm 1 (hauteur)  
cm 1 (höhe)

**Colori disponibili:**  
vedi pag. 63

Available colors :  
Couleurs disponibles : pag. 63  
Erhältlich in den Farben :

### FRANGIA CORDONETTO

fringe  
frange  
franse

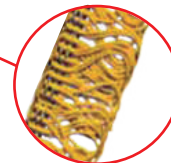

cm 3 (altezza)  
cm 3 (height)  
cm 3 (hauteur)  
cm 3 (höhe)

**Colori disponibili:**  
vedi pag. 63

Available colors :  
Couleurs disponibles : pag. 63  
Verfügen Farben :

### CORDINO - Ø mm 3

rope  
cordon  
Kordel



colore abbinato alla frangia/passamaneria  
color combined with the fringe/trimmings  
couleur assortie à la frange/passementerie  
farbe kombinierte die Fransen/verzierungen

**Colori disponibili:**  
vedi pag. 64

Available colors :  
Couleurs disponibles : pag. 64  
Verfügen Farben :

### BORCHIA - Ø mm 7

stud  
clou  
chef



Disponibile in OTTONE DORATO o OTTONE CROMATO

Available in golden or chrome brass  
Disponibile en laiton doré ou chromé  
Verfügbar in gold oder Verchromt Messing

Material available :  
Matériel disponible : **Materiale disponibile** Tipologia di stampa : Type of printing  
Material verfügbar : Type d'impression  
Art der Druck

<b>raso</b> satin	<b>digitale</b> digital numérique
<b>raso Eco</b> cheap satin satin économique wirtschafts satin	<b>neutro</b> (interno cartoncino) neutral (internal cardboard) neutre (carton fin interne) neutral (Internal-Karte)
<b>raso turco</b> turkish satin satin turc satin türkisch	<b>digitale</b> digital numérique
	<b>ricamo</b> embroidery broderie stickerei

**Imbottitura disponibile** : available padding  
: rembourrage disponibles  
: Polsterung verfügbar

**cartoncino** (cardboard - carton - karton)

**Varianti di modello disponibili**  
Model's variants available  
Variantes modèle disponibles  
Modellvarianten zur verfügung



# MODELLO 29

cm 20x29,5 comprensivo di frangia

## Rettangolare con frangia, bacchetta, cordino, senza busta.

Rectangular with rope, fringe, wand, envelope.

Rectangulaire avec frange, cordon, baguette, pochette.

Rechteckig mit Fransen, Umschläge.

GAGLIARDETTI  
pennant  
fanion  
wimpel

cm 29,5



cm 20

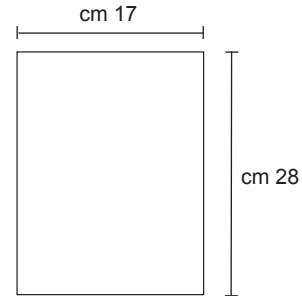

### AREA MASSIMA DI PERSONALIZZAZIONE:

la grafica dovrà essere inserita all'interno dell'area.

### MAXIMUM AREA FOR CUSTOMIZATION:

graphics should be included inside the lines.

### ZONE MAXIMALE DE MARQUAGE:

le graphique devra être inséré à l'intérieur de la zone.

### HÖCHSTFLÄCHE DER PERSONALISIERUNG:

die grafiken sollten die Grafik sollte.

### FRANGIA CORDONETTO

fringe  
frange  
franse

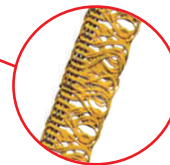

cm 1,5 (altezza)  
cm 1,5 (height)  
cm 1,5 (hauteur)  
cm 1,5 (höhe)

Colori disponibili:  
vedi pag. 63

Available colors :  
Couleurs disponibles : pag. 63  
Verfügen Farben :

### CORDINO - Ø mm 3

rope  
cordon  
Kordel



colore abbinato alla frangia  
color combined with the fringe  
couleur assortie à la frange  
farbe kombinierte die Fransen

Colori disponibili:  
vedi pag. 64

Available colors :  
Couleurs disponibles : pag. 64  
Verfügen Farben :

### BORCHIA - Ø mm 7

stud  
clou  
chef



Disponibile in OTTONE DORATO o OTTONE CROMATO

Available in golden or chrome brass  
Disponibile en laiton doré ou chromé  
Verfügbar in gold oder Verchromt Messing

Material available :  
Matériel disponible :  
Material verfügbar :

### Materiale disponibile

<b>raso</b> satin	
<b>raso Eco</b> cheap satin satin économique wirtschafts satin	<b>digitale</b> digital numérique
<b>raso turco</b> turkish satin satin turc satin türkisch	<b>ricamo</b> embroidery broderie stickerei

### Tipologia di stampa

Type of printing  
Type d'impression  
Art der Druck

<b>digitale</b> digital numérique	
<b>neutro</b> (interno cartoncino) neutral (internal cardboard) neutre (carton fin interne) neutral (Internal-Karte)	

### Imbottitura disponibile

available padding  
rembourrage disponible  
Polsterung verfügbar

**cartoncino** (cardboard - carton - karton)

### Varianti di modello disponibili

Model's variants available  
Variantes modèle disponibles  
Modellvarianten zur Verfügung

- A - cm 18,5x29
- B - cm 23x31
- C - cm 19x29
- D - cm 23x31
- E - cm 18,5x28,5
- G - cm 18,5x28,5  
(solo cucitura)

pag.45

# MODELLO 36

cm 34x27 comprensivo di frangia.

## Rettangolare con frangia, bacchetta, cordino, senza busta.

Rectangular with fringe, wand, rope, without envelope. : Rectangulaire avec frange, cordon, baguette, sans pochette. : Rechteckig mit Fransen, ohne Umschläge.

GAGLIARDETTI  
pennant  
fanion  
wimpel

cm 27

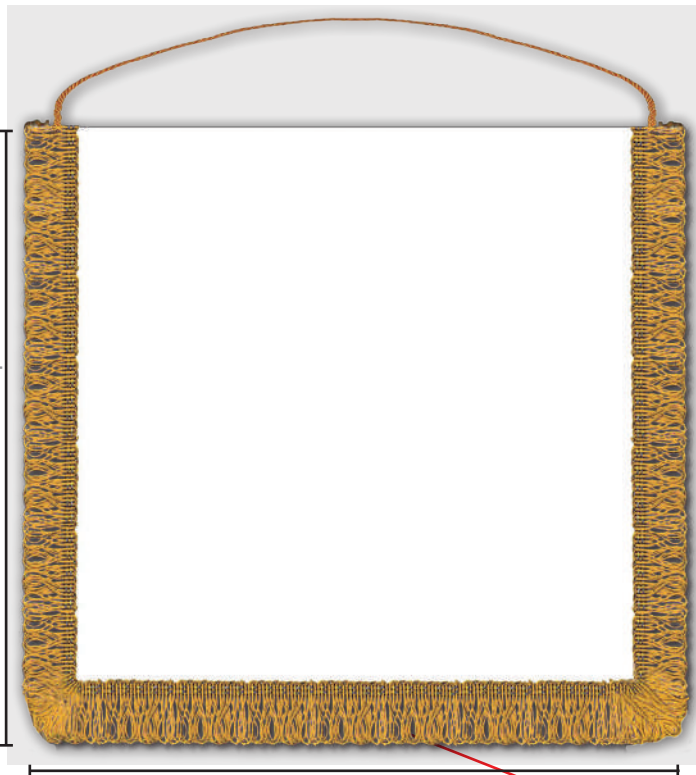

cm 34

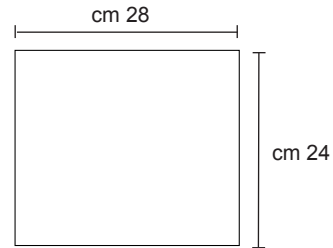

**AREA MASSIMA DI PERSONALIZZAZIONE:**  
la grafica dovrà essere inserita all'interno dell'area.

**MAXIMUM AREA FOR CUSTOMIZATION:**  
graphics should be included inside the lines.

**ZONE MAXIMALE DE MARQUAGE:**  
le graphique devra être inséré à l'intérieur de la zone.

**HÖCHSTFLÄCHE DER PERSONALISIERUNG:**  
die grafiken sollten die Grafik sollte.

### FRANGIA CORDONETTO

fringe  
frange  
franse

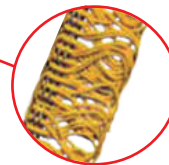

cm 3 (altezza)  
cm 3 (height)  
cm 3 (hauteur)  
cm 3 (höhe)

**Colori disponibili:**  
vedi pag. 63

Available colors :  
Couleurs disponibles : pag. 63  
Verfügen Farben :

### CORDINO - Ø mm 3

rope  
cordon  
Kordel



colore abbinato alla frangia  
color combined with the fringe  
couleur assortie à la frange  
farbe kombinierte die Fransen

**Colori disponibili:**  
vedi pag. 64

Available colors :  
Couleurs disponibles : pag. 64  
Verfügen Farben :

### BORCHIA - Ø mm 9

stud  
clou  
chef



Disponibile in OTTONE DORATO o OTTONE CROMATO

Available in golden or chrome brass  
Disponible en laiton doré ou chromé  
Verfügbar in gold oder Verchromt Messing

Material available :  
Matériel disponible : **Materiale disponibile**  
Material verfügbar :

Tipologia di stampa :  
Type of printing :  
Type d'impression :  
Art der Druck :

<b>raso</b> satin	<b>digitale</b> digital numérique
<b>raso Eco</b> cheap satin satin économique wirtschafts satin	<b>neutro</b> (interno cartoncino) neutral (internal cardboard) neutre (carton fin interne) neutral (Internal-Karte)
<b>raso turco</b> turkish satin satin turc satin türkisch	<b>digitale</b> digital numérique
	<b>ricamo</b> embroidery broderie stickerei

**Imbottitura disponibile** : available padding  
rembourrage disponible  
Polsterung verfügbar

**cartoncino** (cardboard - carton - karton)

**Varianti di modello disponibili**  
Model's variants available  
Variantes modèle disponibles  
Modellvarianten zur verfügung

- A - cm 29,5x25
- C - cm 30x25
- D - cm 34x27
- E - cm 29,5x24,5 + fiocco
- F - cm 31x25,5
- G - cm 29,5x24,5 (solo cucitura)

pag.45



# MODELLO 38

cm 11x42 comprensivo di passamaneria e frangia

## Rettangolare con passamaneria, frangia, cordino cucito, senza bacchetta, senza busta.

Rectangular fringe, trimmings, wand, rope, wi-thout envelope.

Rectangulaire avec franges, passementerie, baguette, cordon, sans pochette.

Rechteckig mit Posament, Fransen, Stab, Umschläge.

GAGLIARDETTI  
pennant  
fanion  
wimpel

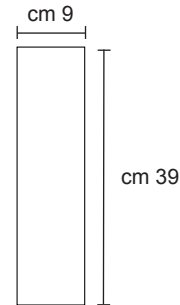
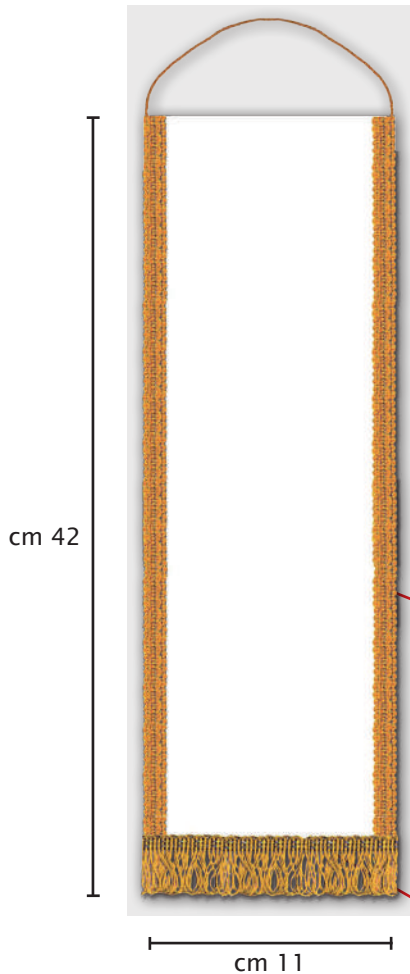

### AREA MASSIMA DI PERSONALIZZAZIONE:

la grafica dovrà essere inserita all'interno dell'area.

MAXIMUM AREA FOR CUSTOMIZATION:  
graphics should be included inside the lines.

SURFACE MAXIMALE DE MARQUAGE:  
le graphique devra être inséré à l'intérieur des lignes.

HÖCHSTFLÄCHE DER PERSONALISIERUNG:  
die grafiken sollten die Grafik sollte.

### PASSAMANERIA

trimmings  
passementerie  
Posament

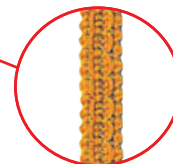

cm 1 (altezza)  
cm 1 (height)  
cm 1 (hauteur)  
cm 1 (höhe)

Colori disponibili:  
vedi pag. 63

Available colors :  
Couleurs disponibles : pag. 63  
Verfügen Farben :

### FRANGIA CORDONETTO

fringe  
frange  
franse



cm 3 (larghezza)  
cm 3 (width)  
cm 3 (largeur)  
cm 3 (breite)

Colori disponibili:  
vedi pag. 63

Available colors :  
Couleurs disponibles : pag. 63  
Verfügen Farben :

### CORDINO - Ø mm 3

rope  
cordon  
Kordel



colore abbinato alla frangia/passamaneria  
color combined with the fringe/trimmings  
couleur assortie à la frange/passementerie  
farbe kombinierte die Fransen/verzierungen

Colori disponibili:  
vedi pag. 64

Available colors :  
Couleurs disponibles : pag. 64  
Verfügen Farben :

Material available :  
Matériel disponible :  
Material verfügbar :

### Materiale disponibile

### Tipologia di stampa

Type of printing  
Type d'impression  
Art der Druck

<b>raso</b> satin	<b>digitale</b> digital numérique
<b>raso Eco</b> cheap satin satin économique wirtschafts satin	<b>neutro</b> (interno cartoncino) neutral (internal cardboard) neutre (carton fin interne) neutral (Internal-Karte)
<b>raso turco</b> turkish satin satin turc satin türkisch	<b>digitale</b> digital numérique
	<b>ricamo</b> embroidery broderie stickerei

### Imbottitura disponibile

available padding  
rembourrage disponibles  
Polsterung verfügbar

**cartoncino** (cardboard - carton - karton)

### Varianti di modello disponibili

Model's variants available  
Variantes modèle disponibles  
Modellvarianten zur verfügung



# MODELLO 39

cm 14x73 comprensivo di passamaneria e frangia.

## Rettangolare con passamaneria, frangia, bacchetta, cordino, senza busta.

Rectangular with fringe, wand, trimmings, without envelope. : Rectangulaire avec franges, passementerie, baguette, cordon, sans pochette. : Rechteckig mit Posament, Fransen, Stab, Umschläge.

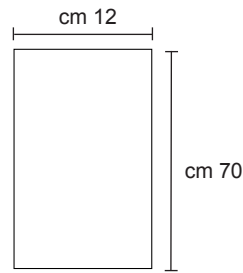
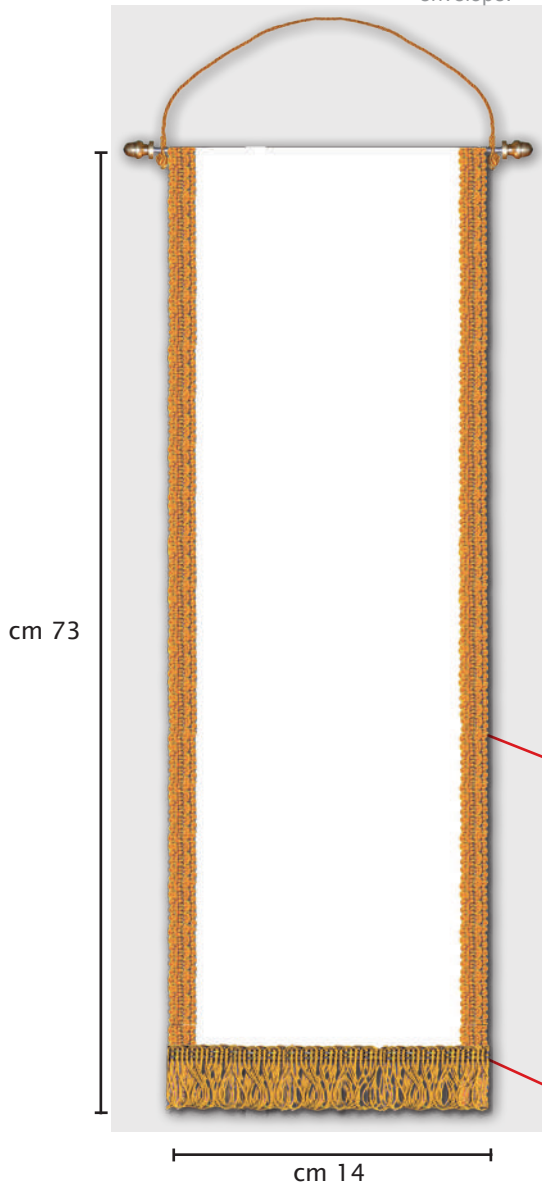

**AREA MASSIMA DI PERSONALIZZAZIONE:**  
la grafica dovrà essere inserita all'interno dell'area.

**MAXIMUM AREA FOR CUSTOMIZATION:**  
graphics should be included inside the lines.

**SURFACE MAXIMALE DE MARQUAGE:**  
le graphique devra être inséré à l'intérieur de la zone.

**HÖCHSTFLÄCHE DER PERSONALISIERUNG:**  
die grafiken sollten die Grafik sollte.

### PASSAMANERIA

trimmings  
passementerie  
Posament

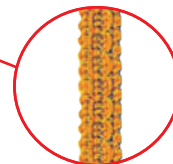

cm 1 (altezza)  
cm 1 (height)  
cm 1 (hauteur)  
cm 1 (höhe)

**Colori disponibili:**  
vedi pag. 63

Available colors :  
Couleurs disponibles : pag. 63  
Verfügen Farben :

### FRANGIA CORDONETTO

fringe  
frange  
franse

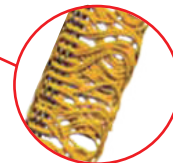

cm 3 (altezza)  
cm 3 (height)  
cm 3 (hauteur)  
cm 3 (höhe)

**Colori disponibili:**  
vedi pag. 63

Available colors :  
Couleurs disponibles : pag. 63  
Verfügen Farben :

### CORDINO - Ø mm 3

rope  
cordon  
Kordel



colore abbinato alla frangia/passamaneria  
color combined with the fringe/trimmings  
couleur assortie à la frange/passementerie  
farbe kombinierte die Fransen/verzierungen

**Colori disponibili:**  
vedi pag. 64

Available colors :  
Couleurs disponibles : pag. 64  
Verfügen Farben :

### BORCHIA - Ø mm 7

stud  
clou  
chef



Disponibile in OTTONE DORATO o OTTONE CROMATO

Available in golden or chrome brass  
Disponible en laiton doré ou chromé  
Verfügbar in gold oder Verchromt Messing

Material available :  
Matériel disponible : **Materiale disponibile** : Type of printing  
Material verfügbar : **Tipologia di stampa** : Type d'impression  
: Art der Druck

<b>raso satin</b>	<b>digitale</b> digital numérique
	<b>neutro</b> (interno cartoncino) neutral (internal cardboard) neutre (carton fin interne) neutral (Internal-Karte)
<b>raso turco</b> turkish satin satin turc satin türkisch	<b>ricamo</b> embroidery broderie stickerei

**Imbottitura disponibile** : available padding  
: rembourrage disponibles  
: Polsterung verfügbar

**cartoncino** (cardboard - carton - karton)

#### Varianti di modello disponibili

Model's variants available  
Variantes modèle disponibles  
Modellvarianten zur Verfügung



### VARIANTE A

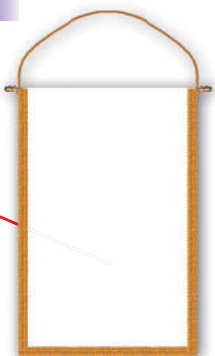
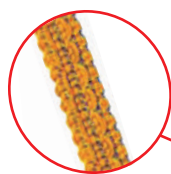

#### Rettangolare con passamaneria (cm 1).

Rectangular with trimming.  
.....  
Rectangulaire avec passementerie.  
.....  
Rechteckig mit Posament.

**Colori disponibili:** Available colors  
vedi pag. 63 Couleurs disponibles  
Verfügen Farben ..... pag. 63

### VARIANTE B

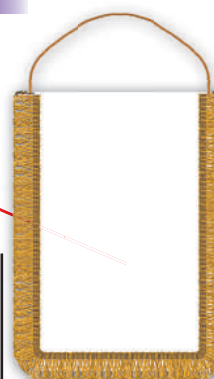
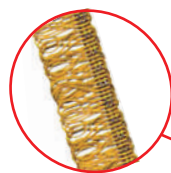

#### Rettangolare con frangia cordonetto (cm 3).

Rectangular with fringe.  
.....  
Rectangulaire avec une frange.  
.....  
Rechteckig mit Fransen.

**Colori disponibili:** Available colors  
vedi pag. 63 Couleurs disponibles  
Verfügen Farben ..... pag. 63

### VARIANTE C

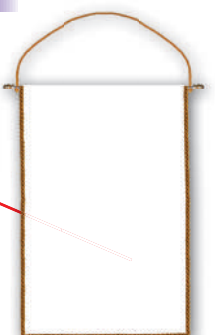

#### Rettangolare con cordino perimetrale (Ø 4 mm).

Rectangular with perimetric rope.  
.....  
Rectangulaire avec cordon périmétral.  
.....  
Rechteckig mit Lanyard.

**Colori disponibili:** Available colors  
vedi pag. 64 Couleurs disponibles  
Verfügen Farben ..... pag. 64

### VARIANTE D

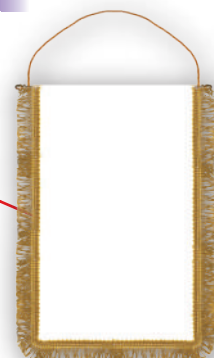

#### Rettangolare con frangia tripolino (cm 3).

Rectangular with Tripoli.  
.....  
Rectangulaire avec Tripoli.  
.....  
Rechteckig mit Tripolis.

**Colori disponibili:** Available colors  
vedi pag. 63 Couleurs disponibles  
Verfügen Farben ..... pag. 63

### VARIANTE E



#### Rettangolare solo cucitura con fiocco (cm 5).

Rectangular only sewn with tassel.  
.....  
Rectangulaire couture avec pompon.  
.....  
Rechteckig nur Naht mit Schleife.

**Colori disponibili:** Available colors  
vedi pag. 63 Couleurs disponibles  
Verfügen Farben ..... pag. 63

### VARIANTE F

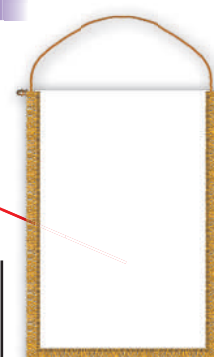

#### Rettangolare con frangia cordonetto (cm 1,5).

Rectangular with fringe and rope.  
.....  
Rectangulaire frange et cordon  
.....  
Rechteckig nur Naht.

**Colori disponibili:** Available colors  
vedi pag. 63 Couleurs disponibles  
Verfügen Farben ..... pag. 63

**N.B.**  
Cordino e bacchetta, ove previsti, non variano rispetto al modello scelto.  
La presenza della busta è specificata dalla variante del modello scelto.

Rope and wand, if provided, do not vary compared to the model chosen. The presence of the envelope is specified by the type of the chosen model.

Cordon et baguette, si fournis, ne varient pas par rapport au modèle choisi.  
La présence de la pochette est définie par la typologie du modèle choisi.

Kordel und Stab, wenn verfügbar, variieren sie nicht in bezug auf das gewählte Modell.

# MODELLO 22

cm 10,5x14,5 comprensivo di frangia

## A scudo con frangia, cordino cucito, busta.

Shield with sewn rope, fringe, envelope.

En bouclier avec frange, cordon cousu, pochette.

Ein Wappen mit Kordel, Umschlag, fransen.

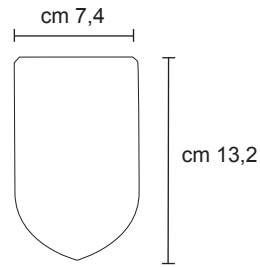

**AREA MASSIMA DI PERSONALIZZAZIONE:**  
la grafica dovrà essere inserita all'interno dell'area.

**MAXIMUM AREA FOR CUSTOMIZATION:**  
graphics should be included inside the lines.

**ZONE MAXIMALE DE MARQUAGE:**  
le graphique devra être inséré à l'intérieur de la zone.

**HÖCHSTFLÄCHE DER PERSONALISIERUNG:**  
die grafiken sollten die Grafik sollte.

GAGLIARDETTI  
pennant  
fanion  
wimpel

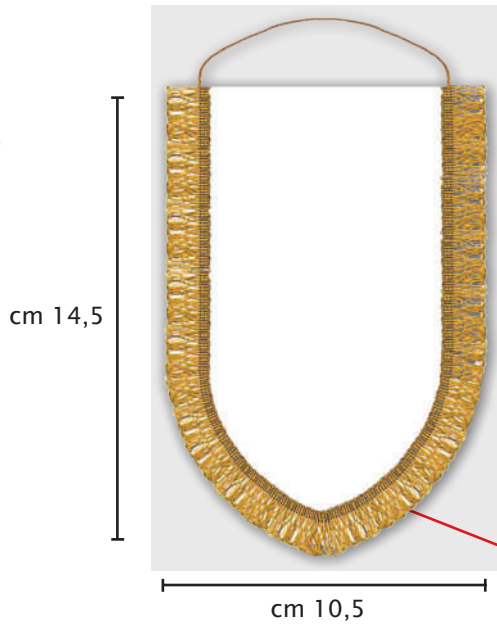

### FRANGIA CORDONETTO

fringe  
frange  
franse

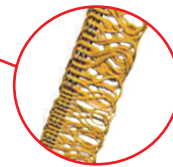

cm 1,5 (altezza)  
cm 1,5 (height)  
cm 1,5 (hauteur)  
cm 1,5 (höhe)

**Colori disponibili:**  
vedi pag. 63

Available colors :  
Couleurs disponibles : pag. 63  
Verfügen Farben :

### CORDINO - Ø mm 2

rope  
cordon  
Kordel



colore abbinato alla frangia  
color combined with the fringe  
couleur assortie à la frange  
farbe kombinierte die Fransen

**Colori disponibili:**  
vedi pag. 64

Available colors :  
Couleurs disponibles : pag. 64  
Verfügen Farben :

Material available :  
Matériel disponible : **Materiale disponibile**  
Material verfügbar :

Tipologia di stampa :  
Type of printing :  
Type d'impression :  
Art der Druck :

<b>raso</b> satin	<b>digitale</b> digital numérique <b>neutro</b> (interno cartoncino) neutre (carton fin interne) neutral (Internal-Karte)
<b>raso Eco</b> cheap satin satin économique wirtschafts satin	<b>digitale</b> digital numérique

**Imbottitura disponibile** : available padding  
: rembourrage disponible  
: Polsterung verfügbar

**cartoncino** (cardboard - carton - karton)

**Varianti di modello disponibili**

Model's variants available  
Variantes modèle disponibles  
Modellvarianten zur Verfügung

- A** - cm 9x14 (busta)
- B** - cm 13,5x16,5
- C** - cm 9,4x14,5 (busta)
- E** - cm 8,5x14 + fiocco
- G** - cm 8,5x14  
(solo cucitura) + busta

pag.53



# MODELLO 9

cm 13,5x16,5 comprensivo di frangia

## A scudo con frangia, cordino cucito, senza busta.

Shield with sewn rope, without envelope.

En bouclier avec frange, cordon cousu, sans pochette.

Ein Wappen mit Kordel, Umschlag

GAGLIARDETTI  
pennant  
fanion  
wimpel

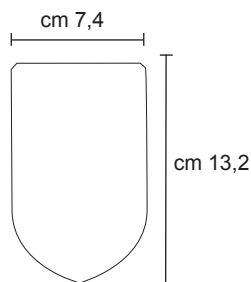

### AREA MASSIMA DI PERSONALIZZAZIONE:

la grafica dovrà essere inserita all'interno dell'area.

MAXIMUM AREA FOR CUSTOMIZATION:  
graphics should be included inside the lines.

ZONE MAXIMALE DE MARQUAGE:  
le graphique devra être inséré à l'intérieur de la zone.

HÖCHSTFLÄCHE DER PERSONALISIERUNG:  
die grafiken sollten die Grafik sollte.

### FRANGIA TRIPOLINO

fringe  
frange  
franse



cm 3 (altezza)  
cm 3 (height)  
cm 3 (hauteur)  
cm 3 (höhe)

Colori disponibili:  
vedi pag. 63

Available colors :  
Couleurs disponibles : pag. 63  
Verfügen Farben :

### CORDINO - Ø mm 2

rope  
cordon  
Kordel



colore abbinato alla frangia  
color combined with the fringe  
couleur assortie à la frange  
farbe kombinierte die Fransen

Colori disponibili:  
vedi pag. 64

Available colors :  
Couleurs disponibles : pag. 64  
Verfügen Farben :

Material available : Matériel disponible : Material verfügbar :	<b>Materiale disponibile</b>	Tipologia di stampa : Type of printing : Type d'impression : Art der Druck :
<b>raso satin</b>		<b>digitale</b> digital numérique  neutral (internal cardboard) <b>neutro</b> (interno cartoncino) neutre (carton fin interne) neutral (Internal-Karte)
<b>raso Eco</b> cheap satin satin économique wirtschafts satin		<b>digitale</b> digital numérique

**Imbottitura disponibile** : available padding  
: rembourrage disponible  
: Polsterung verfügbar

**cartoncino** (cardboard - carton - karton)

### Varianti di modello disponibili

Model's variants available  
Variantes modèle disponibles  
Modellvarianten zur Verfügung

**A** - cm 9x14 (busta)  
**B** - cm 13,5x16,5  
**C** - cm 9,5x14,5 (busta)  
**E** - cm 9x14 + fiocco  
**G** - cm 9x14  
(solo cucitura) + busta

pag.53



# MODELLO 33

cm 15,5x18,5 comprensivo di frangia

## A scudo con frangia, cordino cucito, busta.

Shield with sewn rope  
fringe envelope.

En bouclier avec frange,  
cordon cousu, pochette.

Ein Wappen mit Kordel, Um-  
schlag, fransen.

GAGLIARDETTI  
pennant  
fanion  
wimpel

cm 18,5



cm 15,5

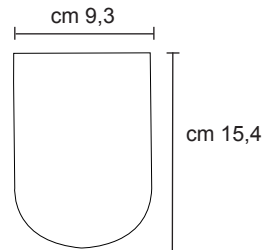

### AREA MASSIMA DI PERSONALIZZAZIONE:

la grafica dovrà essere inserita all'interno dell'area.

MAXIMUM AREA FOR CUSTOMIZATION:  
graphics should be included inside the lines.

ZONE MAXIMALE DE MARQUAGE:  
le graphique devra être inséré à l'intérieur de la zone.

HÖCHSTFLÄCHE DER PERSONALISIERUNG:  
die grafiken sollten die Grafik sollte.

### FRANGIA CORDONETTO

fringe  
frange  
franse

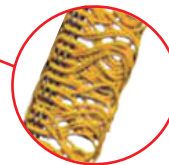

cm 3 (altezza)  
cm 3 (height)  
cm 3 (hauteur)  
cm 3 (höhe)

Colori disponibili:  
vedi pag. 63

Available colors :  
Couleurs disponibles : pag. 63  
Verfügen Farben :

### CORDINO - Ø mm 2

rope  
cordon  
Kordel



colore abbinato alla frangia  
color combined with the fringe  
couleur assortie à la frange  
farbe kombinierte die Fransen

Colori disponibili:  
vedi pag. 64

Available colors :  
Couleurs disponibles : pag. 64  
Verfügen Farben :

Material available :  
Matériel disponible : **Materiale disponibile**  
Material verfügbar :

Tipologia di stampa :  
Type of printing :  
Type d'impression :  
Art der Druck :

<b>raso</b> satin	<b>digitale</b> digital numérique
<b>raso Eco</b> cheap satin satin économique wirtschafts satin	<b>neutro</b> (interno cartoncino) neutral (internal cardboard) neutre (carton fin interne) neutral (Internal-Karte)
<b>raso turco</b> turkish satin satin turc satin türkisch	<b>digitale</b> digital numérique
	<b>ricamo</b> embroidery broderie stickerei

**Imbottitura disponibile** : available padding  
: rembourrage disponible  
: Polsterung verfügbar

**spugna** (sponge - éponge - schwamm)  
**cartoncino** (cardboard - carton - karton)

### Varianti di modello disponibili

Model's variants available  
Variantes de modèle disponibles  
Modellvarianten zur Verfügung

**A** - cm 11x16  
**C** - cm 11,5x16,5  
**D** - cm 15,5x18,5 (busta)  
**E** - cm 10,5x16 + fiocco  
**F** - cm 12,5x17  
**G** - cm 10,5x16  
(solo cucitura)

pag.53



# MODELLO 23

cm 20,5x28 comprensivo di frangia

## A scudo con frangia, bacchetta, cordino, busta.

Shield with rope, fringe envelope wand.

En bouclier avec frange, cordon, baguette, pochette.

Ein Wappen mit Kordel, Umschlag, fransen, Staub.

GAGLIARDETTI  
pennant  
fanion  
wimpel

cm 28



cm 20,5

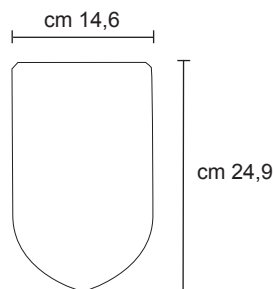

### AREA MASSIMA DI PERSONALIZZAZIONE:

la grafica dovrà essere inserita all'interno dell'area.

MAXIMUM AREA FOR CUSTOMIZATION:  
graphics should be included inside the lines.

ZONE MAXIMALE DE MARQUAGE:  
le graphique devra être inséré à l'intérieur de la zone.

HÖCHSTFLÄCHE DER PERSONALISIERUNG:  
die grafiken sollten die Grafik sollte.

### FRANGIA CORDONETTO

fringe  
frange  
franse

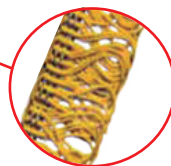

cm 3 (altezza)  
cm 3 (height)  
cm 3 (hauteur)  
cm 3 (höhe)

Colori disponibili:  
vedi pag. 63

Available colors :  
Couleurs disponibles : pag. 63  
Verfügen Farben :

Material available :  
Matériel disponible :  
Material verfügbar :

**Materiale disponibile**

**Tipologia di stampa**

Type of printing  
Type d'impression  
Art der Druck

<b>raso</b> satin	<b>digitale</b> digital numérique
<b>raso Eco</b> cheap satin satin économique wirtschafts satin	<b>neutro</b> (interno cartoncino) neutral (internal cardboard) neutre (carton fin interne) neutral (Internal-Karte)
<b>raso turco</b> turkish satin satin turc satin türkisch	<b>digitale</b> digital numérique
	<b>ricamo</b> embroidery broderie stickerei

**Imbottitura disponibile**

available padding  
rembourrage disponible  
Polsterung verfügbar

**spugna** (sponge - éponge - schwamm)  
**cartoncino** (cardboard - carton - karton)

**Varianti di modello disponibili**

Model's variants available  
Variantes de modèle disponibles  
Modellvarianten zur verfügung

A - cm 16x25,5  
C - cm 17x26  
D - cm 20,5x28 (busta)  
E - cm 16x25,5 + fiocco  
F - cm 17,5x26,5  
G - cm 16x25,5  
(solo cucitura)

pag.53

### CORDINO - Ø mm 3

rope  
cordon  
Kordel



colore abbinato alla frangia  
color combined with the fringe  
couleur assortie à la frange  
farbe kombinierte die Fransen

Colori disponibili:  
vedi pag. 64

Available colors :  
Couleurs disponibles : pag. 64  
Verfügen Farben :

### BORCHIA - Ø mm 7

stud  
clou  
chef



Disponibile in OTTONE DORATO o  
OTTONE CROMATO

Available in golden or chrome brass  
Disponible en laiton doré ou chromé  
Verfügbar in gold oder Verchromt Messing

# MODELLO 21

cm 27,5x28,5 comprensivo di frangia

## A scudo con frangia, bacchetta, cordino, busta.

Shield with rope, fringe envelope wand.

En bouclier avec frange, cordon, baguette, pochette.

Ein Wappen mit Kordel, Umschlag, fransen, Staub.

GAGLIARDETTI  
pennant  
fanion  
wimpel

cm 28,5

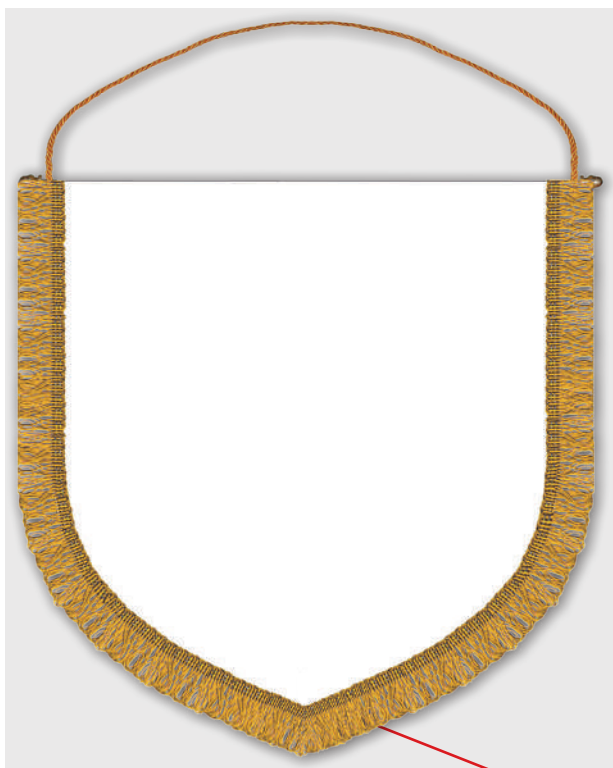

cm 27,5

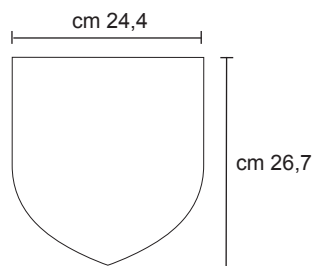

### AREA MASSIMA DI PERSONALIZZAZIONE:

la grafica dovrà essere inserita all'interno dell'area.

MAXIMUM AREA FOR CUSTOMIZATION:  
graphics should be included inside the lines.

ZONE MAXIMALE DE MARQUAGE:  
le graphique devra être inséré à l'intérieur de la zone.

HÖCHSTFLÄCHE DER PERSONALISIERUNG:  
die grafiken sollten die Grafik sollte.

### FRANGIA CORDONETTO

fringe  
frange  
franse



cm 1,5 (altezza)  
cm 1,5 (height)  
cm 1,5 (hauteur)  
cm 1,5 (höhe)

Colori disponibili:  
vedi pag. 63

Available colors :  
Couleurs disponibles : pag. 63  
Verfügen Farben :

### CORDINO - Ø mm 3

rope  
cordon  
Kordel



colore abbinato alla frangia  
color combined with the fringe  
couleur assortie à la frange  
farbe kombinierte die Fransen

Colori disponibili:  
vedi pag. 64

Available colors :  
Couleurs disponibles : pag. 64  
Verfügen Farben :

### BORCHIA - Ø mm 9

stud  
clou  
chef



Disponibile in OTTONE DORATO o OTTONE CROMATO

Available in golden or chrome brass  
Disponible en laiton doré ou chromé  
Verfügbar in gold oder Verchromt Messing

Material available :  
Matériel disponible : **Materiale disponibile**  
Material verfügbar :

Tipologia di stampa :  
Type of printing :  
Type d'impression :  
Art der Druck :

<b>raso</b> satin	<b>digitale</b> digital numérique
<b>raso Eco</b> cheap satin satin économique wirtschafts satin	<b>neutro</b> (interno cartoncino) neutral (internal cardboard) neutre (carton fin interne) neutral (Internal-Karte)
<b>raso turco</b> turkish satin satin turc satin türkisch	<b>digitale</b> digital numérique
	<b>ricamo</b> embroidery broderie stickerei

**Imbottitura disponibile** : available padding  
rembourrage disponible  
Polsterung verfügbar

**spugna** (sponge - éponge - schwamm)  
**cartoncino** (cardboard - carton - karton)

### Varianti di modello disponibili

Model's variants available  
Variantes de modèle disponibles  
Modellvarianten zur verfügung

- A - cm 26x27,5 (busta)
- B - cm 30,5x29,5
- C - cm 26,5x28 (busta)
- D - cm 30,5x29,5
- E - cm 26x27,5 + fiocco
- G - cm 26x27,5 (solo cucitura)

pag.53



# MODELLO 2

cm 26,5x34 comprensivo di frangia

## A scudo con frangia, bacchetta, cordino, busta.

Shield with rope, fringe envelope wand.

En bouclier avec frange, cordon, baguette, pochette.

Ein Wappen mit Kordel, Umschlag, fransen, Staub.

GAGLIARDETTI  
pennant  
fanion  
wimpel



cm 34

cm 26,5

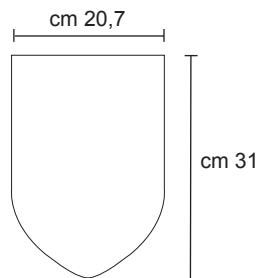

### AREA MASSIMA DI PERSONALIZZAZIONE:

la grafica dovrà essere inserita all'interno dell'area.

MAXIMUM AREA FOR CUSTOMIZATION:  
graphics should be included inside the lines.

ZONE MAXIMALE DE MARQUAGE:  
le graphique devra être inséré à l'intérieur de la zone.

HÖCHSTFLÄCHE DER PERSONALISIERUNG:  
die grafiken sollten die Grafik sollte.

### FRANGIA CORDONETTO

fringe  
frange  
franse

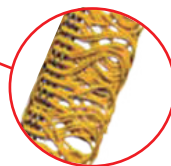

cm 3 (altezza)  
cm 3 (height)  
cm 3 (hauteur)  
cm 3 (höhe)

Colori disponibili:  
vedi pag. 63

Available colors :  
Couleurs disponibles : pag. 63  
Verfügen Farben :

### CORDINO - Ø mm 3

rope  
cordon  
Kordel



colore abbinato alla frangia  
color combined with the fringe  
couleur assortie à la frange  
farbe kombinierte die Fransen

Colori disponibili:  
vedi pag. 64

Available colors :  
Couleurs disponibles : pag. 64  
Verfügen Farben :

### BORCHIA - Ø mm 9

stud  
clou  
chef



Disponibile in OTTONE DORATO o OTTONE CROMATO

Available in golden or chrome brass  
Disponible en laiton doré ou chromé  
Verfügar in gold oder Verchromt Messing

Material available :  
Matériel disponible :  
Material verfügbar :

### Materiale disponibile

<b>raso</b> satin	
<b>raso Eco</b> cheap satin satin économique wirtschafts satin	<b>digitale</b> digital numérique
<b>raso turco</b> turkish satin satin turc satin türkisch	<b>ricamo</b> embroidery broderie stickerei

### Tipologia di stampa

Type of printing  
Type d'impression  
Art der Druck

<b>digitale</b> digital numérique
<b>neutro</b> (interno cartoncino) neutral (internal cardboard) neutre (carton fin interne) neutral (Internal-Karte)

### Imbottitura disponibile

available padding  
rembourrage disponible  
Polsterung verfügbar

<b>spugna</b> (sponge - éponge - schwamm)
<b>cartoncino</b> (cardboard - carton - karton)

### Varianti di modello disponibili

Model's variants available  
Variantes de modèle disponibles  
Modellvarianten zur verfügung

- A - cm 22,5x32
- C - cm 23x32
- D - cm 26,5x34 (busta)
- E - cm 22x31,5 + fiocco
- F - cm 23,5x32,5
- G - cm 22x31,5 (solo cucitura)

pag.53

# MODELLO 41

cm 32x43 comprensivo di frangia

## A scudo con frangia, bacchetta, cordino, busta.

Shield with rope, fringe envelope wand.

En bouclier avec frange, cordon, baguette, pochette.

Ein Wappen mit Kordel, Umschlag, fransen, Staub.



GAGLIARDETTI  
pennant  
fanion  
wimpel

cm 43

cm 32

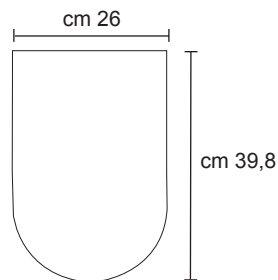

### AREA MASSIMA DI PERSONALIZZAZIONE:

la grafica dovrà essere inserita all'interno dell'area.

MAXIMUM AREA FOR CUSTOMIZATION:  
graphics should be included inside the lines.

ZONE MAXIMALE DE MARQUAGE:  
le graphique devra être inséré à l'intérieur de la zone.

HÖCHSTFLÄCHE DER PERSONALISIERUNG:  
die grafiken sollten die Grafik sollte.

### FRANGIA CORDONETTO

fringe  
frange  
franse



cm 3 (altezza)  
cm 3 (height)  
cm 3 (hauteur)  
cm 3 (höhe)

Colori disponibili:  
vedi pag. 63

Available colors :  
Couleurs disponibles : pag. 63  
Verfügen Farben :

### CORDINO - Ø mm 3

rope  
cordon  
Kordel



colore abbinato alla frangia  
color combined with the fringe  
couleur assortie à la frange  
farbe kombinierte die Fransen

Colori disponibili:  
vedi pag. 64

Available colors :  
Couleurs disponibles : pag. 64  
Verfügen Farben :

### BORCHIA - Ø mm 9

stud  
clou  
chef



Disponibile in OTTONE DORATO o OTTONE CROMATO

Available in golden or chrome brass  
Disponibile en laiton doré ou chromé  
Verfügbar in gold oder Verchromt Messing

Material available :  
Matériel disponible : **Materiale disponibile**  
Material verfügbar :

Tipologia di stampa :  
Type of printing :  
Type d'impression :  
Art der Druck :

<b>raso</b> satin	<b>digitale</b> digital numérique <b>neutro (interno cartoncino)</b> neutral (internal cardboard) neutre (carton fin interne) neutral (Internal-Karte)
<b>raso Eco</b> cheap satin satin économique wirtschafts satin	<b>digitale</b> digital numérique
<b>raso turco</b> turkish satin satin turc satin türkisch	<b>ricamo</b> embroidery broderie stickerei

**Imbottitura disponibile** : available padding :  
rembourrage disponible :  
Polsterung verfügbar :

**spugna** (sponge - éponge - schwamm)  
**cartoncino** (cardboard - carton - karton)

### Varianti di modello disponibili

Model's variants available  
Variantes de modèle disponibles  
Modellvarianten zur verfügung

**A** - cm 27,5x40,5  
**C** - cm 28x41 (busta)  
**D** - cm 32x43 (busta)  
**E** - cm 27,5x40,5 + fiocco  
**F** - cm 29x41,5  
**G** - cm 27,5x40,5 (solo cucitura)

pag.53



### VARIANTE A

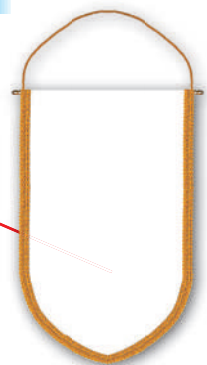
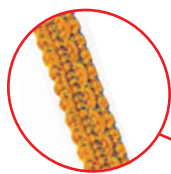

#### A scudo con passamaneria (cm 1).

Shield with trimming.

En bouclier avec passementerie.

Ein Schild mit Posament.

**Colori disponibili:** Available colors  
vedi pag. 63 Couleurs disponibles  
Verfügen Farben

pag. 63

### VARIANTE B

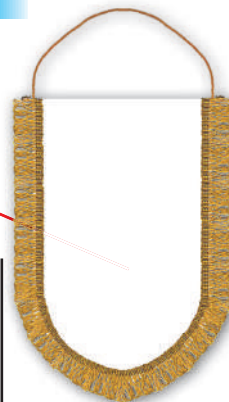
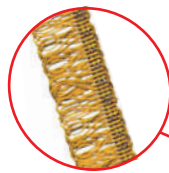

#### A scudo con frangia cordonetto (cm 3).

Shield with fringe.

En bouclier avec une frange.

Ein Schild mit Fransen.

**Colori disponibili:** Available colors  
vedi pag. 63 Couleurs disponibles  
Verfügen Farben

pag. 63

### VARIANTE C

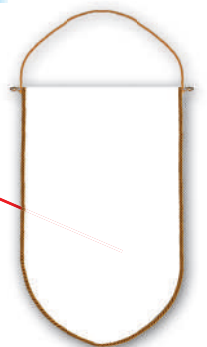

#### A scudo con cordino perimetrale (Ø 4 mm).

Shield with perimetric rope.

En bouclier avec cordon périmétral.

Ein Schild mit Lanyard Umfang.

**Colori disponibili:** Available colors  
vedi pag. 64 Couleurs disponibles  
Verfügen Farben

pag. 64

### VARIANTE D



#### A scudo con frangia tripolino (cm 3).

Shield with Tripoli.

En bouclier avec Tripoli.

Ein Schild mit Tripolis.

**Colori disponibili:** Available colors  
vedi pag. 63 Couleurs disponibles  
Verfügen Farben

pag. 63

### VARIANTE E



#### A scudo solo cucitura con fiocco (cm 5).

Shield only sewn with tassel.

En bouclier couture pompon.

Ein Schild nur Naht mit Schleife.

**Colori disponibili:** Available colors  
vedi pag. 63 Couleurs disponibles  
Verfügen Farben

pag. 63

### VARIANTE F

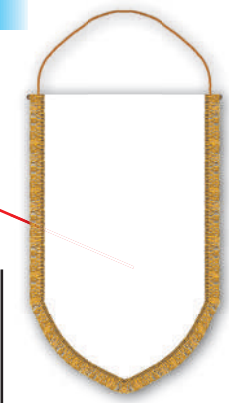

#### A scudo con frangia cordonetto (cm 1,5).

Shield only fringe and rope.

En bouclier frange cordon.

Ein Schild nur Naht.

**Colori disponibili:** Available colors  
vedi pag. 63 Couleurs disponibles  
Verfügen Farben

pag. 63

#### N.B.

Cordino e bacchetta, ove previsti, non variano rispetto al modello scelto.

La presenza della busta è specificata dalla variante del modello scelto.

Rope and wand, if provided, do not vary compared to the model chosen. The presence of the envelope is specified by the type of the chosen model.

Cordon et baguette, si fournis, ne varient pas par rapport au modèle choisi.

La présence de la pochette est définie par la typologie du modèle choisi.

Kordel und Stab, wenn verfügbar, variieren sie nicht in bezug auf das gewählte Modell.

# MODELLO 37

cm 17,5x24,5

## Speciale con bacchetta, cordino, senza frangia e senza busta.

Special, wand, rope, Spécial avec baguette : Besondere mit Stab, Kordel, without fringe and et cordon, sans frange : ohne Fransen und ohne without envelope. et sans pochette : Umschlag.

GAGLIARDETTI  
pennant  
fanion  
wimpel

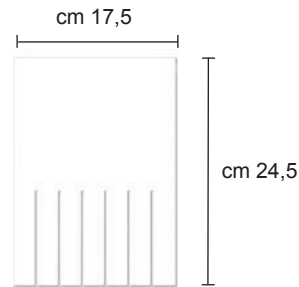
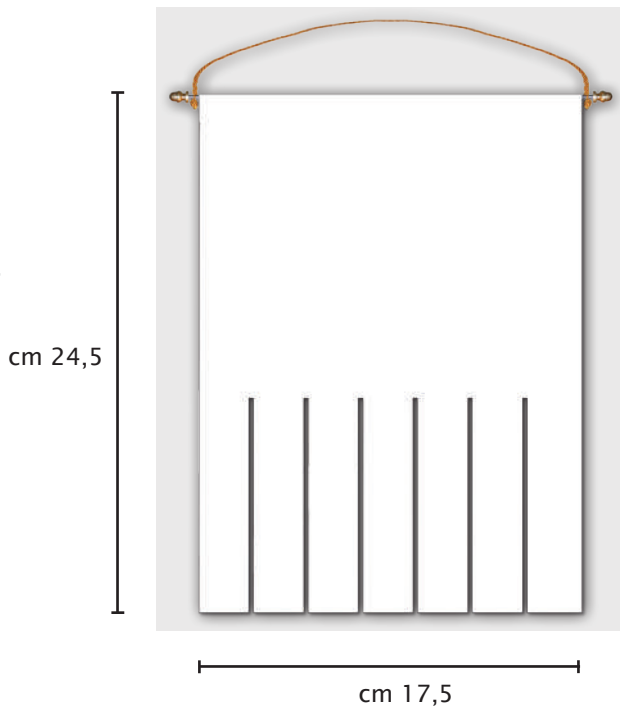

### AREA MASSIMA DI PERSONALIZZAZIONE:

la grafica dovrà essere inserita all'interno dell'area.

MAXIMUM AREA FOR CUSTOMIZATION:  
graphics should be included inside the lines.

SURFACE MAXIMALE DE MARQUAGE:  
le graphique devra être inséré à l'intérieur de la zone.

HÖCHSTFLÄCHE DER PERSONALISIERUNG:  
die grafiken sollten die Grafik sollte.

### CORDINO - Ø mm 3

rope  
cordon  
Kordel



colore a scelta  
color of your choice  
couleur au choix  
Farbwahl

Colori disponibili:  
vedi pag. 64

Available colors :  
Couleurs disponibles : pag. 64  
Verfügen Farben :

### BORCHIA - Ø mm 7

stud  
clou  
chef



Disponibile in OTTONE DORATO o  
OTTONE CROMATO

Available in golden or chrome brass  
Disponible en laiton doré ou chromé  
Verfügbar in gold oder Verchromt Messing

Material available :  
Matériel disponible : **Materiale disponibile**  
Material verfügbar :

Tipologia di stampa :  
Type of printing :  
Type d'impression :  
Art der Druck :

<b>raso</b> satin	<b>digitale</b> digital numérique
<b>raso Eco</b> cheap satin satin économique wirtschafts satin	<b>neutro</b> (interno cartoncino) neutral (internal cardboard) neutre (carton fin interne) neutral (Internal-Karte)
<b>raso turco</b> turkish satin satin turc satin türkisch	<b>digitale</b> digital numérique
	<b>ricamo</b> embroidery broderie stickerei

**Imbottitura disponibile** : available padding  
: rembourrage disponibles  
: Polsterung verfügbar

**cartoncino** (cardboard - carton - karton)

### Varianti di modello disponibili

Model's variants available  
Variantes modèle disponibles  
Modellvarianten zur verfügung



# MODELLO 27

cm 15x29,5

**Speciale con bacchetta, cordino, senza frangia e senza busta.**

Special wand, rope, Spéciale avec baguette, Besondere mit Stab, Kordel, without fringe and without cordon, sans frange, ohne Fransen und ohne envelope. et sans pochette. Umschlag.

GAGLIARDETTI  
pennant  
fanion  
wimpel

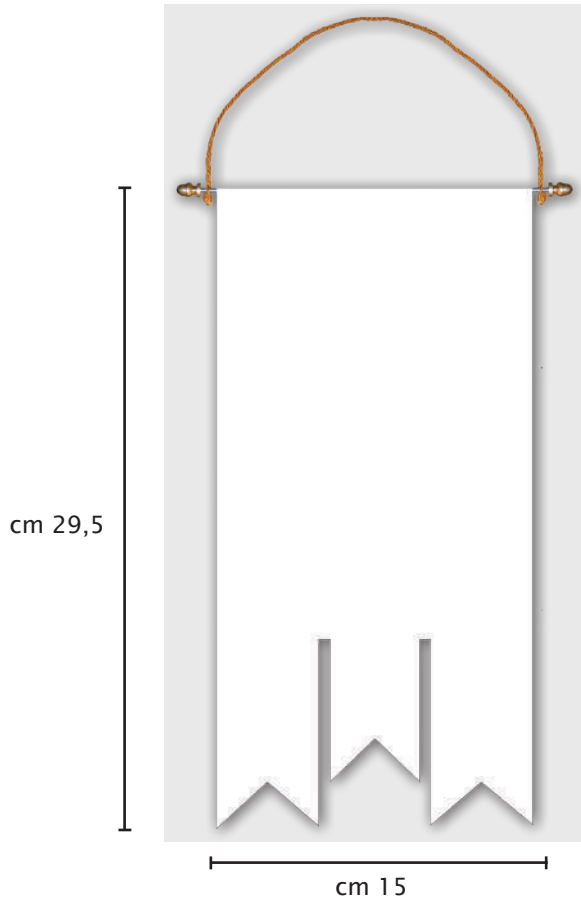

cm 29,5

cm 15

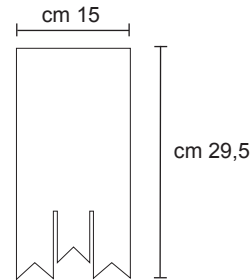

### AREA MASSIMA DI PERSONALIZZAZIONE:

la grafica dovrà essere inserita all'interno dell'area.

### MAXIMUM AREA FOR CUSTOMIZATION:

graphics should be included inside the lines.

### SURFACE MAXIMALE DE MARQUAGE:

le graphique devra être inséré à l'intérieur de la zone.

### HÖCHSTFLÄCHE DER PERSONALISIERUNG:

die grafiken sollten die Grafik sollte.

### CORDINO - Ø mm 3

rope  
cordon  
Kordel



colore a scelta  
color of your choice  
couleur au choix  
Farbwahl

Colori disponibili:  
vedi pag. 64

Available colors :  
Couleurs disponibles : pag. 64  
Verfügen Farben :

### BORCHIA - Ø mm 7

stud  
clou  
chef



Disponibile in OTTONE DORATO o  
OTTONE CROMATO

Available in golden or chrome brass  
Disponible en laiton doré ou chromé  
Verfügbar in gold oder Verchromt Messing

Material available :  
Matériel disponible : **Materiale disponibile**  
Material verfügbar :

Tipologia di stampa :  
Type of printing :  
Type d'impression :  
Art der Druck :

<b>raso</b> satin	<b>digitale</b> digital numérique
<b>raso Eco</b> cheap satin satin économique wirtschafts satin	<b>neutro</b> (interno cartoncino) neutral (internal cardboard) neutre (carton fin interne) neutral (Internal-Karte)
<b>raso turco</b> turkish satin satin turc satin türkisch	<b>digitale</b> digital numérique
	<b>ricamo</b> embroidery broderie stickerei

**Imbottitura disponibile** : available padding  
: rembourrage disponibles  
: Polsterung verfügbar

**cartoncino** (cardboard - carton - karton)

### Varianti di modello disponibili

Model's variants available  
Variantes modèle disponibles  
Modellvarianten zur verfügung



# MODELLO 30

cm 20x31 comprensivo di  
passamaneria e frangia

## Speciale con passamaneria, frangia, bacchetta, cordino, busta.

Special, fringe, trimmings,  
wand, rope, envelope.

Spécial avec frange,  
passementerie, cordon,  
baguette, pochette.

Besondere mit Posament,  
Fransen, Kordel, Umschlag.

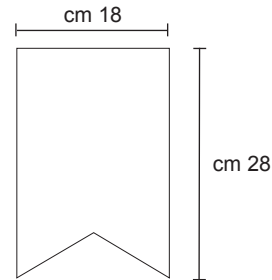

### AREA MASSIMA DI PERSONALIZZAZIONE:

la grafica dovrà essere inserita all'interno dell'area.

MAXIMUM AREA FOR CUSTOMIZATION:  
graphics should be included inside the lines.

SURFACE MAXIMALE DE MARQUAGE:  
le graphique devra être inséré à l'intérieur de la zone.

HÖCHSTFLÄCHE DER PERSONALISIERUNG:  
die grafiken sollten die Grafik sollte.

### PASSAMANERIA

trimmings  
passementerie  
Posament

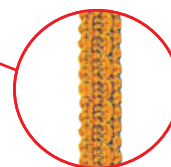

cm 1 (altezza)  
cm 1 (height)  
cm 1 (hauteur)  
cm 1 (höhe)

Colori disponibili:  
vedi pag. 63

Available colors :  
Couleurs disponibles : pag. 63  
Verfügen Farben :

### FRANGIA CORDONETTO

fringe  
frange  
franse

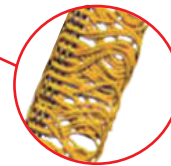

cm 3 (altezza)  
cm 3 (height)  
cm 3 (hauteur)  
cm 3 (höhe)

Colori disponibili:  
vedi pag. 63

Available colors :  
Couleurs disponibles : pag. 63  
Verfügen Farben :

### CORDINO - Ø mm 3

rope  
cordon  
Kordel



colore abbinato alla frangia/passamaneria  
color combined with the fringe/trimmings  
couleur combiné la frange/passementerie  
farbe kombinierte die Fransen/verzierungen

Colori disponibili:  
vedi pag. 64

Available colors :  
Couleurs disponibles : pag. 64  
Verfügen Farben :

### BORCHIA - Ø mm 7

stud  
clou  
chef



Disponibile in OTTONE DORATO o  
OTTONE CROMATO

Available in golden or chrome brass  
Disponibile en laiton doré ou chromé  
Verfügbar in gold oder Verchromt Messing

GAGLIARDETTI  
pennant  
fanion  
wimpel

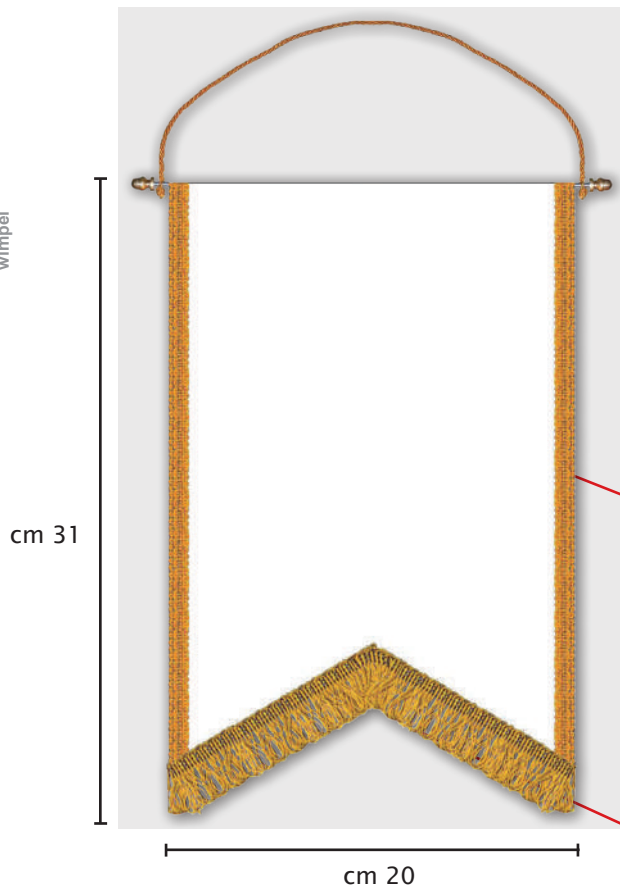

Material available :  
Matériel disponible :  
Material verfügbar :

### Materiale disponibile

### Tipologia di stampa

Type of printing  
Type d'impression  
Art der Druck

<b>raso</b> satin	<b>digitale</b> digital numérique
<b>raso Eco</b> cheap satin satin économique wirtschafts satin	<b>digitale</b> digital numérique
<b>raso turco</b> turkish satin satin turc satin türkisch	<b>ricamo</b> embroidery broderie stickerei
	<b>neutro</b> (interno cartoncino) neutral (internal cardboard) neutre (carton fin interne) neutral (Internal-Karte)

### Imbottitura disponibile

available padding  
rembourrage disponibles  
Polsterung verfügbar

**cartoncino** (cardboard - carton - karton)

### Varianti di modello disponibili

Model's variants available  
Variantes modèle disponibles  
Modellvarianten zur verfügung



# MODELLO 28

cm 22x29 comprensivo di passamaneria

## Speciale con passamaneria, bacchetta, cordino, senza busta.

Special, trimmings, wand, rope, without envelope.

Spécial avec passementerie, baguette, cordon, sans pochette.

Besondere mit Posament, Kordel, Umschlag.

GAGLIARDETTI  
pennant  
fanion  
wimpel

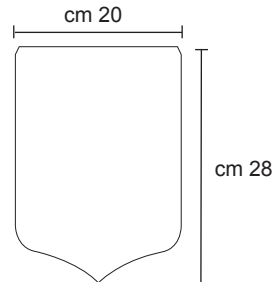
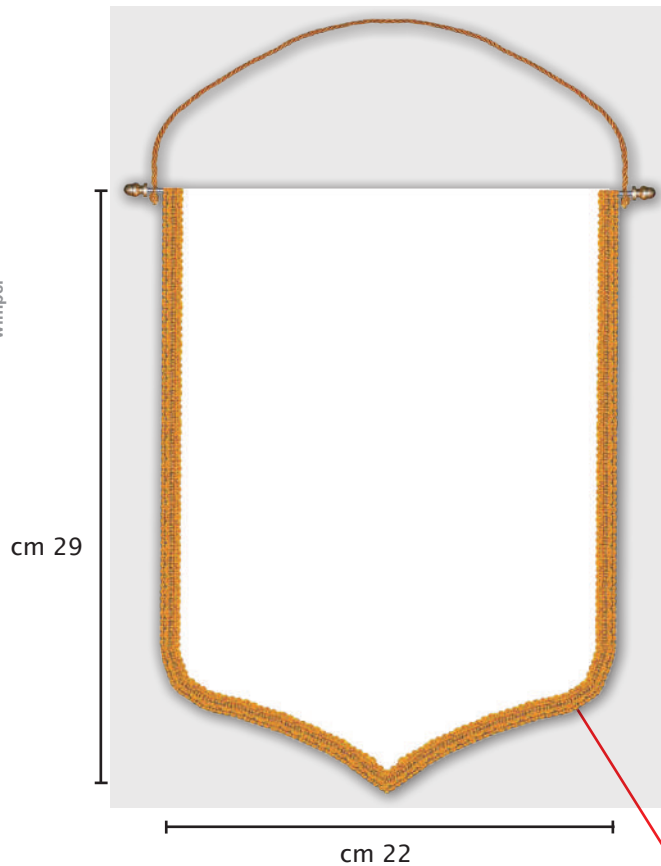

### AREA MASSIMA DI PERSONALIZZAZIONE:

la grafica dovrà essere inserita all'interno dell'area.

MAXIMUM AREA FOR CUSTOMIZATION:  
graphics should be included inside the lines.

SURFACE MAXIMALE DE MARQUAGE:  
le graphique devra être inséré à l'intérieur de la zone.

HÖCHSTFLÄCHE DER PERSONALISIERUNG:  
die grafiken sollten die Grafik sollte.

### PASSAMANERIA

trimmings  
passementerie  
Posament

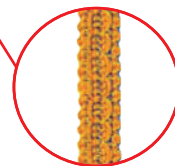

cm 1 (altezza)  
cm 1 (height)  
cm 1 (hauteur)  
cm 1 (höhe)

Colori disponibili:  
vedi pag. 63

Available colors :  
Couleurs disponibles : pag. 63  
Verfügen Farben :

### CORDINO - Ø mm 3

rope  
cordon  
Kordel



colore abbinato alla passamaneria  
color combined with the trimmings  
couleur assortie à la passementerie  
farbe kombinierte die Verzierungen

Colori disponibili:  
vedi pag. 64

Available colors :  
Couleurs disponibles : pag. 64  
Verfügen Farben :

### BORCHIA - Ø mm 9

stud  
clou  
chef



Disponibile in OTTONE DORATO o OTTONE CROMATO

Available in golden or chrome brass  
Disponible en laiton doré ou chromé  
Verfügbar in gold oder Verchromt Messing

Material available :  
Matériel disponible :  
Material verfügbar :

### Materiale disponibile

### Tipologia di stampa

Type of printing  
Type d'impression  
Art der Druck

<b>raso</b> satin	<b>digitale</b> digital numérique
<b>raso Eco</b> cheap satin satin économique wirtschafts satin	<b>neutro (interno cartoncino)</b> neutral (internal cardboard) neutre (carte interne) neutral (Internal-Karte)
<b>raso turco</b> turkish satin satin turc satin türkisch	<b>digitale</b> digital numérique
	<b>ricamo</b> embroidery broderie stickerei

### Imbottitura disponibile

available padding  
rembourrage disponibles  
Polsterung verfügbar

**spugna** (sponge - éponge - schwamm)  
**cartoncino** (cardboard - carton - karton)

### Varianti di modello disponibili

Model's variants available  
Variantes de modèle disponibles  
Modellvarianten zur verfügung

MADE IN ITALY



# MODELLO 46

cm 21x26 comprensivo di  
passamaneria e frangia

## Speciale con passamaneria, frangia, bacchetta, cordino, senza busta.

Special with fringe, trim-  
mings, wand, rope, wi-  
thout envelope.

Spécial avec frange, pas-  
sementerie, baguette,  
cordon, sans pochette.

Besondere mit Posament,  
Fransen, Kordel, Umschlag.

GAGLIARDETTI  
pennant  
fanion  
wimpel

cm 26

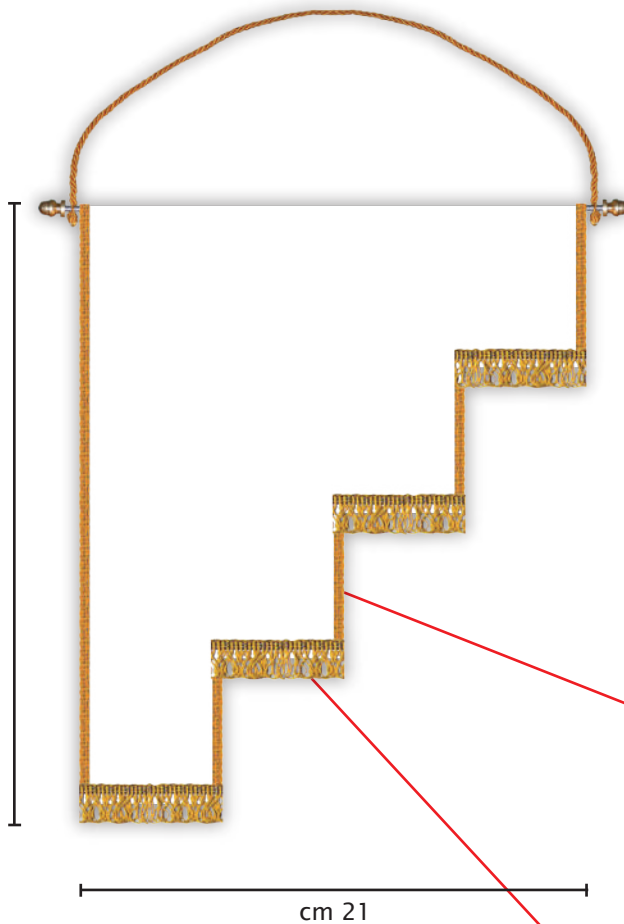

cm 21

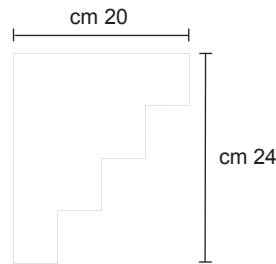

### AREA MASSIMA DI PERSONALIZZAZIONE:

la grafica dovrà essere inserita all'interno dell'area.

MAXIMUM AREA FOR CUSTOMIZATION:  
graphics should be included inside the lines.

SURFACE MAXIMALE DE MARQUAGE:  
le graphique devra être inséré à l'intérieur de la zone.

HÖCHSTFLÄCHE DER PERSONALISIERUNG:  
die grafiken sollten die Grafik sollte.

### PASSAMANERIA

trimmings  
passementerie  
Posament

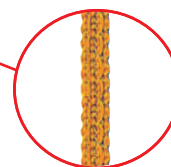

cm 0,4 (altezza)  
cm 0,4 (height)  
cm 0,4 (hauteur)  
cm 0,4 (höhe)

Colori disponibili:  
vedi pag. 63

Available colors :  
Couleurs disponibles : pag. 63  
Verfügen Farben :

### FRANGIA CORDONETTO

fringe  
frange  
franse

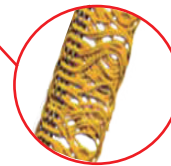

cm 1,5 (altezza)  
cm 1,5 (height)  
cm 1,5 (hauteur)  
cm 1,5 (höhe)

Colori disponibili:  
vedi pag. 63

Available colors :  
Couleurs disponibles : pag. 63  
Verfügen Farben :

### CORDINO - Ø mm 3

rope  
cordon  
Kordel



colore abbinato alla frangia/passamaneria  
color combined with the fringe/trimmings  
couleur assortie à la frange/passementerie  
farbe kombinierte die Fransen/verzierungen

Colori disponibili:  
vedi pag. 64

Available colors :  
Couleurs disponibles : pag. 64  
Verfügen Farben :

### BORCHIA - Ø mm 9

stud  
clou  
chef



Disponibile in OTTONE DORATO o  
OTTONE CROMATO

Available in golden or chrome brass  
Disponibile en laiton doré ou chromé  
Verfügar in gold oder Verchromt Messing

Material available :  
Matériel disponible :  
Material verfügbar :

### Materiale disponibile

### Tipologia di stampa

Type of printing  
Type d'impression  
Art der Druck

<b>raso</b> satin	<b>digitale</b> digital numérique
<b>raso Eco</b> cheap satin satin économique wirtschafts satin	<b>neutro</b> (interno cartoncino) neutral (internal cardboard) neutre (carte interne) neutral (Internal-Karte)
<b>raso turco</b> turkish satin satin turc satin türkisch	<b>digitale</b> digital numérique
	<b>ricamo</b> embroidery broderie stickerei

### Imbottitura disponibile

available padding  
rembourrage disponibles  
Polsterung verfügbar

**cartoncino** (cardboard - carton - karton)

### Varianti di modello disponibili

Model's variants available  
Variantes modèle disponibles  
Modellvarianten zur verfügung



# MODELLO 8

cm 21,5x34 comprensivo di passamaneria

## Speciale con passamaneria, bacchetta, cordino, busta.

Special, trimmings, wand, rope, envelope.

Spécial avec passementerie, baguette, cordon, pochette.

Besondere mit Posament, Kordel, Umschlag.

GAGLIARDETTI  
pennant  
fanion  
wimpel

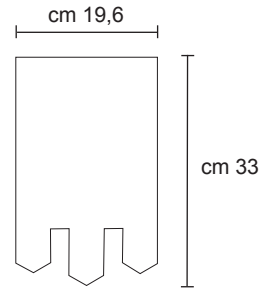
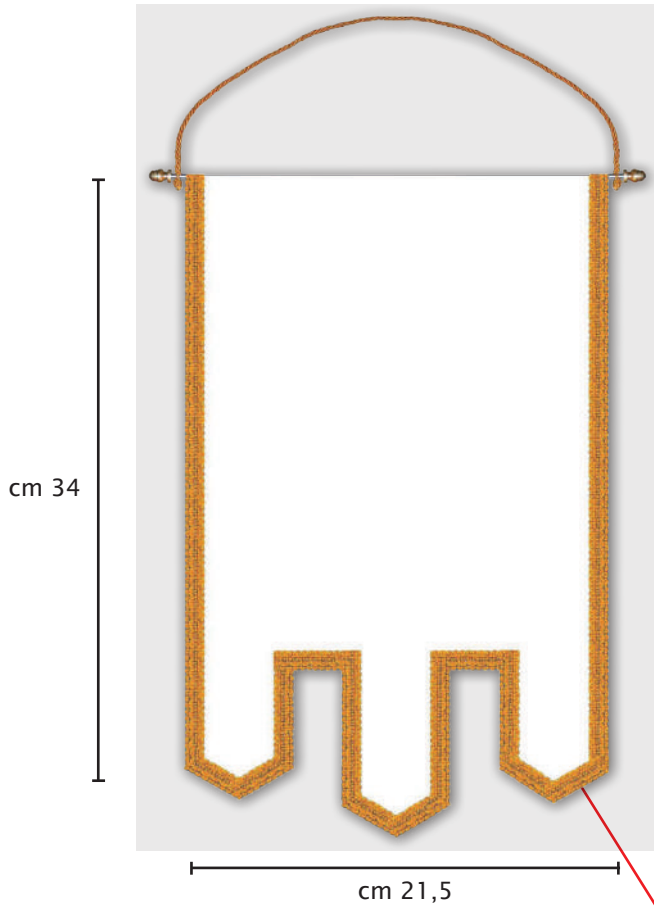

**AREA MASSIMA DI PERSONALIZZAZIONE:**  
la grafica dovrà essere inserita all'interno dell'area.

**MAXIMUM AREA FOR CUSTOMIZATION:**  
graphics should be included inside the lines.

**SURFACE MAXIMALE DE MARQUAGE:**  
le graphique devra être inséré à l'intérieur de la zone.

**HÖCHSTFLÄCHE DER PERSONALISIERUNG:**  
die grafiken sollten die Grafik sollte.

### PASSAMANERIA

trimmings  
passementerie  
Posament

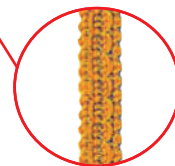

cm 1 (altezza)  
cm 1 (height)  
cm 1 (hauteur)  
cm 1 (höhe)

**Colori disponibili:**  
vedi pag. 63

Available colors :  
Couleurs disponibles : pag. 63  
Verfügen Farben :

### CORDINO - Ø mm 3

rope  
cordon  
Kordel



colore abbinato alla passamaneria  
color combined with the trimmings  
couleur assortie à la passementerie  
farbe kombinierte die Verzierungen

**Colori disponibili:**  
vedi pag. 64

Available colors :  
Couleurs disponibles : pag. 64  
Verfügen Farben :

### BORCHIA - Ø mm 9

stud  
clou  
chef



Disponibile in OTTONE DORATO o OTTONE CROMATO

Available in golden or chrome brass  
Disponibile en laiton doré ou chromé  
Verfügbar in gold oder Verchromt Messing

Material available :  
Matériel disponible :  
Material verfügbar :

#### Materiale disponibile

#### Tipologia di stampa

Type of printing  
Type d'impression  
Art der Druck

<b>raso satin</b>	<b>digitale</b> digital numérique
<b>raso Eco</b> cheap satin satin économique wirtschafts satin	<b>neutro (interno cartoncino)</b> neutral (internal cardboard) neutre (carton fin interne) neutral (Internal-Karte)
<b>raso turco</b> turkish satin satin turc satin türkisch	<b>digitale</b> digital numérique
	<b>ricamo</b> embroidery broderie stickerei

#### Imbottitura disponibile

available padding  
rembourrage disponibles  
Polsterung verfügbar

**cartoncino** (cardboard - carton - karton)

#### Varianti di modello disponibili

Model's variants available  
Variantes modèle disponibles  
Modellvarianten zur verfügung



# MODELLO 11

cm 21x34,5 comprensivo di passamaneria

## Speciale con passamaneria, bacchetta, cordino, busta.

Special with cord, braids, wand, envelope.

Spécial avec passementerie, baguette, cordon, pochette.

Besondere mit Posament, Kordel, Umschlag.

GAGLIARDETTI  
pennant  
fanion  
wimpel

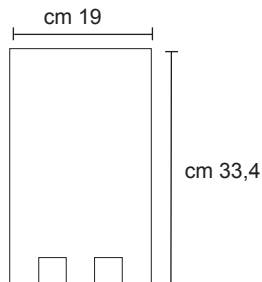
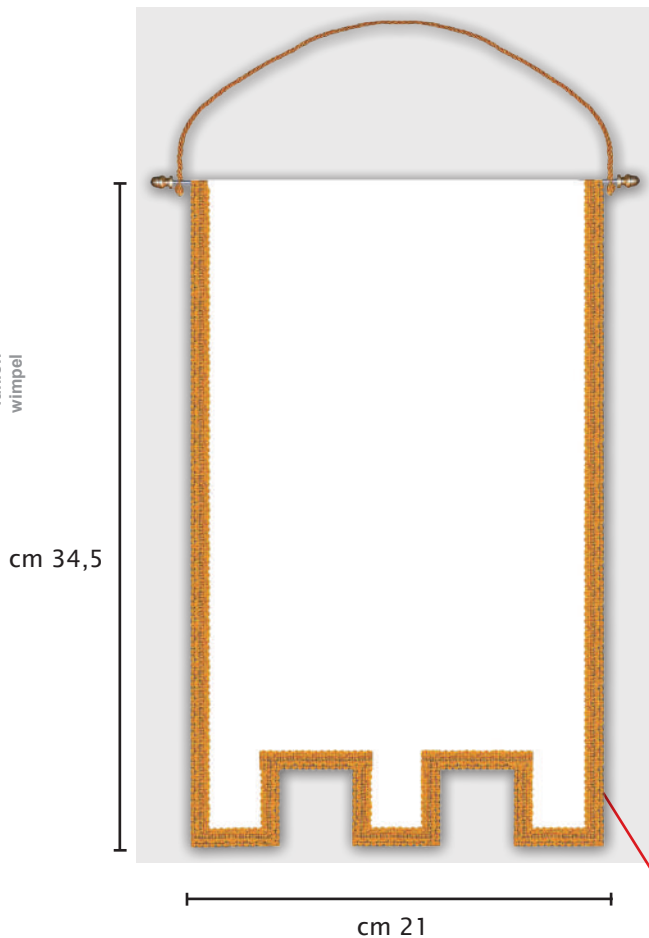

### AREA MASSIMA DI PERSONALIZZAZIONE:

la grafica dovrà essere inserita all'interno dell'area.

MAXIMUM AREA FOR CUSTOMIZATION:  
graphics should be included inside the lines.

SURFACE MAXIMALE DE MARQUAGE:  
le graphique devra être inséré à l'intérieur de la zone.

HÖCHSTFLÄCHE DER PERSONALISIERUNG:  
die grafiken sollten die Grafik sollte.

### PASSAMANERIA

trimmings  
passementerie  
Posament

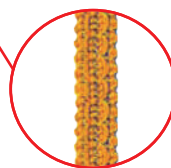

cm 1 (altezza)  
cm 1 (height)  
cm 1 (hauteur)  
cm 1 (höhe)

Colori disponibili:  
vedi pag. 63

Available colors :  
Couleurs disponibles : pag. 63  
Verfügen Farben :

### CORDINO - Ø mm 3

rope  
cordon  
Kordel



colore abbinato alla passamaneria  
color combined with the trimmings  
couleur assortie à la passementerie  
farbe kombinierte die Verzierungen

Colori disponibili:  
vedi pag. 64

Available colors :  
Couleurs disponibles : pag. 64  
Verfügen Farben :

### BORCHIA - Ø mm 9

stud  
clou  
chef



Disponibile in OTTONE DORATO o OTTONE CROMATO

Available in golden or chrome brass  
Disponibile en laiton doré ou chromé  
Verfügbar in gold oder Verchromt Messing

Material available :  
Matériel disponible :  
Material verfügbar :

### Materiale disponibile

### Tipologia di stampa

Type of printing  
Type d'impression  
Art der Druck

<b>raso</b> satin	<b>digitale</b> digital numérique
<b>raso Eco</b> cheap satin satin économique wirtschafts satin	<b>neutro</b> (interno cartoncino) neutral (internal cardboard) neutre (carte interne) neutral (Internal-Karte)
<b>raso turco</b> turkish satin satin turc satin türkisch	<b>digitale</b> digital numérique
	<b>ricamo</b> embroidery broderie stickerei

### Imbottitura disponibile

available padding  
rembourrage disponibles  
Polsterung verfügbar

**cartoncino** (cardboard - carton - karton)

### Varianti di modello disponibili

Model's variants available  
Variantes modèle disponibles  
Modellvarianten zur verfügung



# MODELLO 44

cm 21,5x33,5 comprensivo di frangia

## Speciale con frangia, bacchetta, cordino, busta.

Special with fringe, wand, rope, envelope.

Spécial avec frange, baguette, cordon, pochette.

Besondere mit Posament, Kordel, Umschlag.

GAGLIARDETTI  
pennant  
fanion  
wimpel

cm 33,5

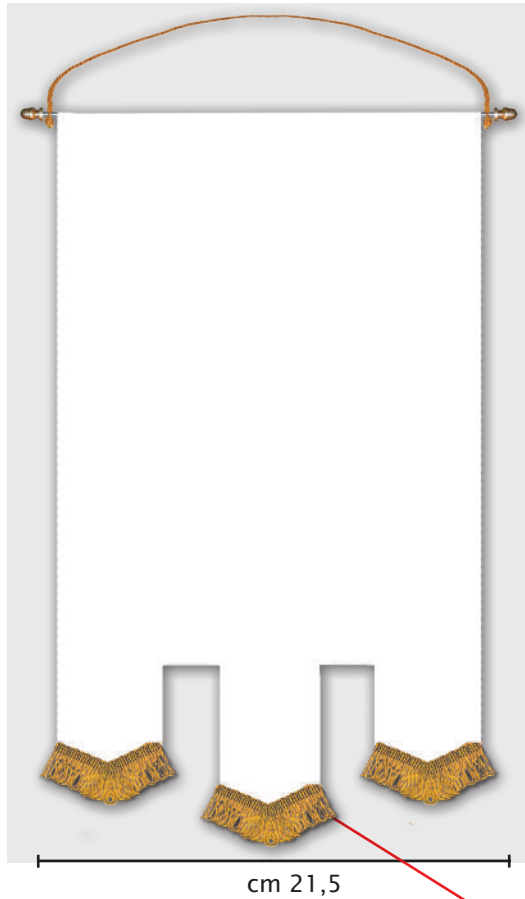

cm 21,5

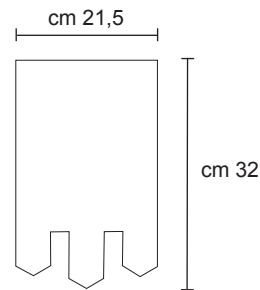

### AREA MASSIMA DI PERSONALIZZAZIONE:

la grafica dovrà essere inserita all'interno dell'area.

MAXIMUM AREA FOR CUSTOMIZATION:  
graphics should be included inside the lines.

SURFACE MAXIMALE DE MARQUAGE:  
le graphique devra être inséré à l'intérieur de la zone.

HÖCHSTFLÄCHE DER PERSONALISIERUNG:  
die grafiken sollten die Grafik sollte.

### FRANGIA CORDONETTO

fringe  
frange  
franse

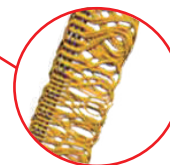

cm 1,5 (altezza)  
cm 1,5 (height)  
cm 1,5 (hauteur)  
cm 1,5 (höhe)

Colori disponibili:  
vedi pag. 63

Available colors :  
Couleurs disponibles : pag. 63  
Verfügen Farben :

### CORDINO - Ø mm 3

rope  
cordon  
Kordel



colore abbinato alla frangia  
color combined with the fringe  
couleur assortie à la frange  
farbe kombinierte die Fransen

Colori disponibili:  
vedi pag. 64

Available colors :  
Couleurs disponibles : pag. 64  
Verfügen Farben :

### BORCHIA - Ø mm 9

stud  
clou  
chef



Disponibile in OTTONE DORATO o OTTONE CROMATO

Available in golden or chrome brass  
Disponibile en laiton doré ou chromé  
Verfügbar in gold oder Verchromt Messing

Material available :  
Matériel disponible :  
Material verfügbar :

### Materiale disponibile

### Tipologia di stampa

Type of printing :  
Type d'impression :  
Art der Druck :

<b>raso</b> satin	<b>digitale</b> digital numérique
<b>raso Eco</b> cheap satin satin économique wirtschafts satin	<b>neutro (interno cartoncino)</b> neutral (internal cardboard) neutre (carte interne) neutral (Internal-Karte)
<b>raso turco</b> turkish satin satin turc satin türkisch	<b>digitale</b> digital numérique
	<b>ricamo</b> embroidery broderie stickerei
: available padding : rembourrage disponibles : Polsterung verfügbar	
<b>spugna</b> (sponge - éponge - schwamm)	
<b>cartoncino</b> (cardboard - carton - karton)	

Model's variants available  
Variantes de modèle disponibles  
Modellvarianten zur verfügung

# MODELLO 40

cm 27,5x43,5 comprensivo di passamaneria e frangia

## Speciale con passamaneria, frangia, bacchetta, cordino, senza busta.

Special with fringe, trimmings, wand, rope, without envelope.

Special avec frange, passementerie, baguette, cordon, sans pochette.

Besondere mit Posament, Fransen, Kordel, Umschlag.

GAGLIARDETTI  
pennant  
fanion  
wimpel

cm 43,5

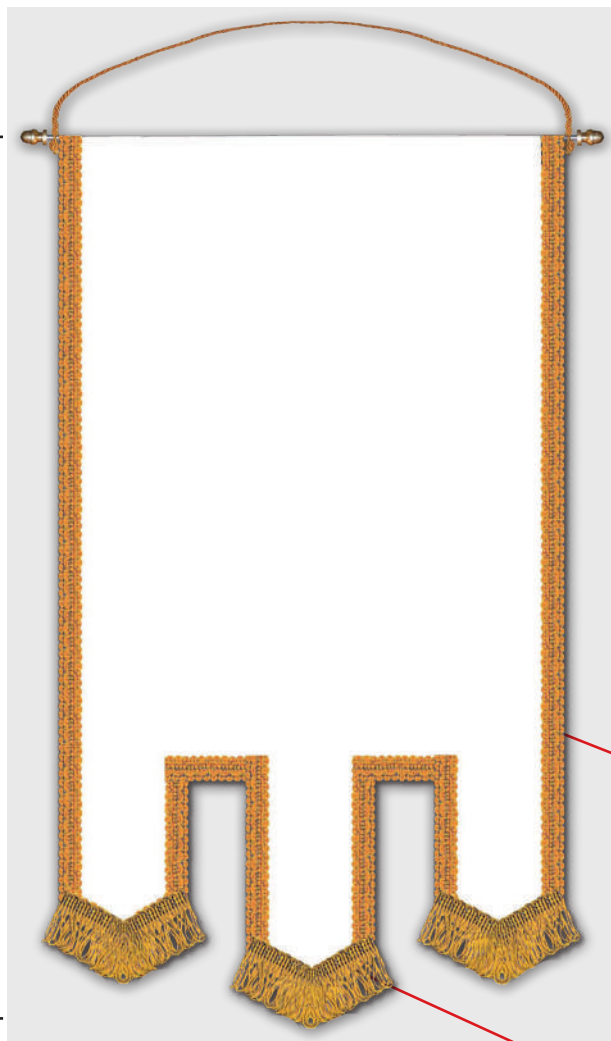

cm 27,5

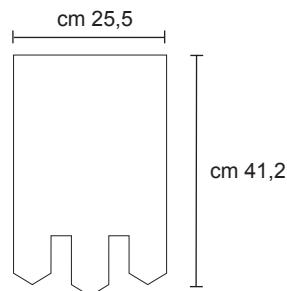

### AREA MASSIMA DI PERSONALIZZAZIONE:

la grafica dovrà essere inserita all'interno dell'area.

MAXIMUM AREA FOR CUSTOMIZATION:  
graphics should be included inside the lines.

SURFACE MAXIMALE DE MARQUAGE:  
le graphique devra être inséré à l'intérieur de la zone.

HÖCHSTFLÄCHE DER PERSONALISIERUNG:  
die grafiken sollten die Grafik sollte.

### PASSAMANERIA

trimmings  
passementerie  
Posament

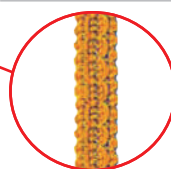

cm 1 (altezza)  
cm 1 (height)  
cm 1 (hauteur)  
cm 1 (höhe)

Colori disponibili:  
vedi pag. 63

Available colors :  
Couleurs disponibles : pag. 63  
Verfügen Farben :

### FRANGIA CORDONETTO

fringe  
frange  
franse

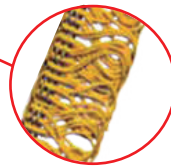

cm 3 (altezza)  
cm 3 (height)  
cm 3 (hauteur)  
cm 3 (höhe)

Colori disponibili:  
vedi pag. 63

Available colors :  
Couleurs disponibles : pag. 63  
Verfügen Farben :

### CORDINO - Ø mm 3

rope  
cordon  
Kordel



colore abbinato alla frangia/passamaneria  
color combined with the fringe/trimmings  
couleur combiné la frange/passementerie  
farbe kombinierte die Fransen/verzierungen

Colori disponibili:  
vedi pag. 64

Available colors :  
Couleurs disponibles : pag. 64  
Verfügen Farben :

### BORCHIA - Ø mm 9

stud  
clou  
chef



Disponibile in OTTONE DORATO o OTTONE CROMATO

Available in golden or chrome  
Disponibile en laiton doré ou chromé  
Verfügar in gold oder Verchromt Messing

Material available :  
Matériel disponible :  
Material verfügbar :

### Materiale disponibile

### Tipologia di stampa

Type of printing  
Type d'impression  
Art der Druck

<b>raso</b> satin	<b>digitale</b> digital numérique
<b>raso Eco</b> cheap satin satin économique wirtschafts satin	<b>neutro (interno cartoncino)</b> neutral (internal cardboard) neutre (carte interne) neutral (Internal-Karte)
<b>raso turco</b> turkish satin satin turc satin türkisch	<b>digitale</b> digital numérique
	<b>ricamo</b> embroidery broderie stickerei

### Imbottitura disponibile

available padding  
rembourrage disponibles  
Polsterung verfügbar

**cartoncino** (cardboard - carton - karton)

### Varianti di modello disponibili

Model's variants available  
Variantes modèle disponibles  
Modellvarianten zur verfügung



### FRANGIA CORDONETTO (cm 3) - 3 fili di acetato ritorti insieme

FRINGE'S ROPE: 3 twisted acetate wires  
FRANGE: 3 fils d'acétate torsadé  
CORDONETTO: 3 Draht zusammen Acetat verdreht

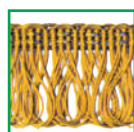

**ORO**  
gold - or - gold



**ARGENTO**  
silver - argent - silber



**NERA**  
black - noir - schwarz

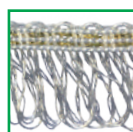

**BIANCA**  
white - blanc - schwarz

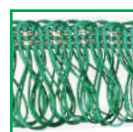

**VERDE**  
green - vert - grün

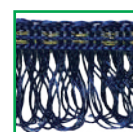

**BLU ROYAL**  
royal blue - bleu roi  
königsblau

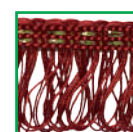

**ROSSA SCURA**  
dark red - rouge foncé  
dunkelrot



**ROSSA**  
red - rouge - rot

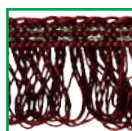

**GRANATA**  
grenade - granate

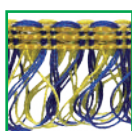

**BLU/GIALLA**  
blue/yellow - bleu/jaune  
blau/gelb

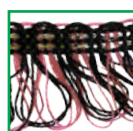

**NERA/ROSSA**  
black/pink - noir/rose  
schwarz/rosa

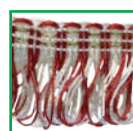

**BIANCA/ROSSA**  
white/red - blanc/rouge  
weiß/rot

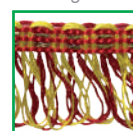

**GIALLA/ROSSA**  
yellow/red - jaune/rouge  
gelb/rot



**BLU/ROSSA**  
blue/red - bleu/rouge  
blau/rot

### FRANGIA TRIPOLINO ANELLATA (cm 3) - 1 filo di acetato lavorato a maglia

TRIPOLINO ringed: 1 knitted acetate wire  
TRIPOLINO en anneaux: 1 fil d'acétate tricoté  
TRIPOLINO geringelt: 1 drahtgest acetat



**GIALLA ORO**  
golden yellow -  
jaune or - gelb gold

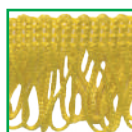

**GIALLA LIMONE**  
yellow lemon  
jaune citron - Zitronengelb



**ROSSA**  
red - rouge - rot

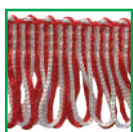

**BIANCA/ROSSA**  
white/red - blanc/rouge  
weiß/rot



**TRICOLORE**  
tricolor - tricolore  
tricolor

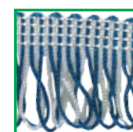

**BIANCA/AZZURRA**  
white/blue - blanc/bleu  
weiß/blau

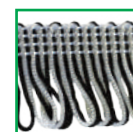

**NERA/BIANCA**  
black/white - noir/blanc  
schwarz/weiß

### FRANGIA TRIPOLINO TAGLIATA (cm 3 / cm 5)

TRIPOLINO cut / TRIPOLINO coupé / TRIPOLINO schnitt

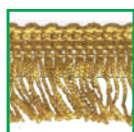

**ORO**  
gold - or - gold



**ORO LUREX**  
gold lurex - or lurex  
gold lurex



**ARGENTO LUREX**  
silver lurex - argent lurex  
silber lurex

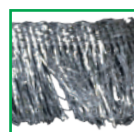

**ARGENTO LAME' LUREX**  
silver lamé lurex  
argent lamé lurex - silber lamé  
lurex

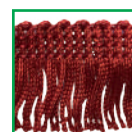

**ROSSA SCURA**  
dark red - rouge foncé  
dunkelrot

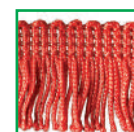

**ROSSA**  
red - rouge - rot

### FRANGIA CORDONETTO (cm 1,5)



**ORO**  
gold - or - gold



**ARGENTO**  
silver - argent - silber



**BIANCA**  
white - blanc - weiß



**ROSSA**  
red - rouge - rot



**GRANATA**  
grenade - granate

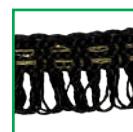

**NERA**  
black - noir  
schwarz



**BLU ROYAL**  
royal blue - bleu roi  
königsblau

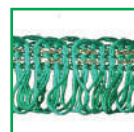

**VERDE**  
green - vert - grün

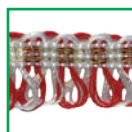

**BIANCA/ROSSA**  
white/red - blanc/rouge  
weiß/rot



**BLU/ROSSA**  
blue/red - bleu/rouge  
blau/rot

### FRANGIA TRIPOLINO TAGLIATA (cm 1,5)



**GIALLA ORO**  
golden yellow - jaune  
or - gelb gold

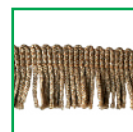

**ORO LUREX**  
gold lurex - or lurex  
gold lurex



**ARGENTO LAME' LUREX**  
silver lamé lurex  
argent lamé lurex - silber lamé  
lurex

### PASSAMANERIA (cm 1) trimmings / passementerie / zutaten



**ORO**  
gold - or - gold



**ORO LUREX**  
gold lurex - or lurex  
gold lurex



**ARGENTO**  
silver - argent - silber



**ARGENTO LUREX**  
silver lurex - argent lurex  
silber lurex



**BIANCA**  
white - blanc - weiß



**BLU SCURO**  
dark blue - bleu foncé  
dunkelblau

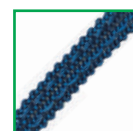

**BLU ROYAL**  
royal blue - bleu royal  
königsblau



**NERA**  
black - noir  
schwarz

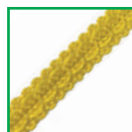

**GIALLA**  
yellow - jaune  
gelb gold



**BIANCA/AZZURRA**  
white/blue - blanc/bleu  
weiß/blau

**Tutte le nostre frange e passamaneria sono disponibili in tanti altri colori, secondo le Vostre richieste.**

All of our fringes and trimmings are available in many other colors, according to your requests.

Toutes nos franges et passementeries sont disponibles dans de nombreux autres coloris en fonction de vos demandes.

Alle unsere Fransen und Verzierungen sind in vielen anderen Farben nach Vs Anfrage.



## CORDINO in acetato

rope acetate  
cordon en acétate  
tragegurt Acetat

- Ø : mm 2



- Ø : mm 3

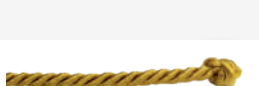

- Ø : mm 6



### Colori disponibili:

Available colors  
Couleurs disponibles  
Verfügen Farben



## CORDONIERA in acetato



- Ø : mm 3  
- fiocco cm 5

**Diametro, lunghezza e colore sono personalizzabili secondo le vostre richieste.**

Diameter, length and color can be customized according to your requests.

Le diamètre, la longueur et la couleur peuvent être personnalisés selon vos demandes.

Durchmesser, Länge und Farbe können nach Ihren Wünschen angepasst werden.

## BASETTE DA TAVOLO

table bases  
support pour table  
Koteltellen Tisch

### OTTONE CROMATO: Ø cm 8,5 - h cm 45 (da 1 a 16 astine)

CHROME BRASS: Ø cm 8,5 - h cm 45  
(from 1 to 16 rods)

LAITON CHROME: Ø cm 8,5 - h cm 45  
(de 1 à 16 tiges)

VERCHROMT MESSING: Ø cm 8,5 - h cm 45  
(von 1 bis 16 Stangen)



130/1



130/2



130/3

### OTTONE LUCIDO: Ø cm 8,5 - h cm 45 (da 1 a 5 astine)

POLISHED BRASS: Ø 8,5 cm - h cm 45  
(from 1 to 5 rods)

LAITON POLI: Ø cm 8,5 - h cm 45  
(de 1 à 5 tiges)

GLANZ MESSING: Ø cm 8,5 - h cm 45  
(von 1 bis 5 Stangen)

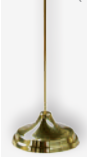

131/1



131/2



131/3



130/C

chromed eco-base  
éco-base chromée  
verchromte Eko-Basis

131/L

golden eco-base  
base d'écho d'or  
goldene Echobasis

268

walnut wood color  
bois couleur noyer  
Nussbaum Farbe



201/T

triangular model  
modèle triangulaire  
Unterputzmodell Dreieck

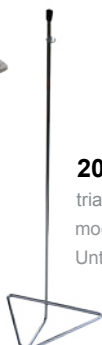

267

marble  
marbre  
Marmor



269

Economic wood rods  
Base en bois économique  
Wirtschafts mehr Auktionen

130/C - **BASETTA ECO CROMATA**  
Ø cm 10 - h: cm 45

131/L - **BASETTA ECO DORATA**  
Ø cm 10 - h: cm 45

201/T - **BASETTA A FILO**  
modello triangolo - h: cm 45

267 - **BASETTA IN MARMO**  
base 7,5x7,5 cm - h: cm 45

268 - **BASETTA IN LEGNO**  
colore noce - h: cm 45

269 - **BASETTA IN LEGNO**  
(da 1 a 5 astine) - h: cm 45

# GAGLIARDETTI IN CORNICE

framed pennants  
fanions encadrés  
wimpel rahmen

CORNICI GAGLIARDETTI

framed pennants - fanions encadrés - wimpel rahmen



## CORNICE DELACROIX (FAR.COR01)

**Cornice a muro, cm. 40x50x4, in legno Ayous con lastra frontale in vetro. Personalizzazione del gagliardetto e dello sfondo della cornice.**

**Modelli gagliardetti compatibili: 1/2/4/20**

FRAME DELACROIX (FAR.COR01):

Wall frame, cm. 40x50x4, Ayous wood with glass.  
Customization available for pennant and for frame's background.  
Compatible pennant's models: 1/2/4/20

CADRE DELACROIX (FAR.COR01):

Cadre mural, cm. 40x50x4, en bois Ayous avec plaque frontale en verre.  
Personnalisation Fanion et arrière-plan du cadre.  
Modèles de fanion compatibles: 1/2/4/20

DELACROIX-RAHMEN (FAR.COR01):

Wandrahmen, cm. 40x50x4, in Ayous Holz mit Glasfrontplatte.  
Wimpelanpassung und der Hintergrund des Rahmens.  
Kompatible Wimpelmodelle: 1/2/4/20



## CORNICE BOYD MEDIA (FAR.COR02)

**Cornice a muro, cm. 35x45x4, in legno nero con lastra frontale in vetro. Personalizzazione del gagliardetto e dello sfondo della cornice.**

**Modelli gagliardetti compatibili: 5/6/14/15/16/17/19/23/24/25/27/28/30/31/32/35/43**

MEDIUM BOYD FRAME (FAR.COR02):

Wall frame, cm. 35x45x4, black wood with glass.  
Customization available for pennant and for frame's background.  
Compatible pennant's models: 5/6/14/15/16/17/19/23/24/25/27/28/30/31/32/35/43

CADRE DE BOYD MOYEN (FAR.COR02):

Cadre mural, cm. 35x45x4, en bois noir avec plaque frontale en verre.  
Personnalisation Fanion et arrière-plan du cadre.  
Modèles de fanion compatibles: 5/6/14/15/16/17/19/23/24/25/27/28/30/31/32/35/43

MEDIUM BOYD RAHMEN (FAR.COR02):

Wandrahmen, cm. 35x45x4, in schwarzem Holz mit Glasfrontplatte.  
Wimpelanpassung und der Hintergrund des Rahmens.  
Kompatible Wimpelmodelle: 5/6/14/15/16/17/19/23/24/25/27/28/30/31/32/35/43

## CORNICE BOYD PICCOLA (FAR.COR03)

**Cornice a muro, cm. 20x25x4, in legno nero con lastra frontale in vetro. Personalizzazione del gagliardetto e dello sfondo della cornice.**

**Modelli gagliardetti compatibili: 3/9/12/18/22/34**

SMALL BOYD FRAME (FAR.COR03):

Wall frame, cm. 20x25x4, black wood with glass.  
Customization available for pennant and for frame's background.  
Compatible pennant's models: 3/9/12/18/22/34

PETIT CADRE DE BOYD (FAR.COR03):

Cadre mural, cm. 20x25x4, en bois noir avec plaque frontale en verre.  
Personnalisation Fanion et arrière-plan du cadre.  
Modèles de fanions compatibles: 3/9/12/18/22/34

KLEINER BOYD RAHMEN (FAR.COR03):

Wandrahmen, cm. 20x25x4, in schwarzem Holz mit Glasfrontplatte.  
Wimpelanpassung und der Hintergrund des Rahmens.  
Kompatible Wimpelmodelle: 3/9/12/18/22/34

## FAR.COR02



## FAR.COR03



### CORNICE BOYD MEDIA

(FAR.COR02)

**Cornice misura 35x45x4,  
con sfondo e gagliardetto medio  
personalizzato.**

MEDIUM BOYD FRAME (FAR.COR02):  
Frame's measures 35x45x4, available customization  
for background and medium pennant.

CADRE DE BOYD MOYEN (FAR.COR02):  
Le cadre mesure 35x45x4, avec un  
arrière-plan et un fanion  
de taille moyenne personnalisé.

MEDIUM BOYD RAHMEN (FAR.COR02):  
Rahmen misst 35x45x4, mit hintergrund  
und benutzerdefinierten medium wimpel

### CORNICE BOYD PICCOLA

(FAR.COR03)

**Cornice misura 20x25x4,  
con sfondo e gagliardetto piccolo  
personalizzato.**

SMALL BOYD FRAME (FAR.COR03):  
Frame's measures 20x25x4, available customization  
for background and small pennant.

CADRE DE BOYD PETIT (FAR.COR03):  
Le cadre mesure 20x25x4,  
avec fond et petit  
fanion personnalisé.

KLEINER BOYD RAHMEN (FAR.COR03):  
Rahmen misst 20x25x4, mit hintergrund  
und kleinem kundenwimpel.

### GAGLIARDETTO DA COLLO

(PRO.COL12)

**Gagliardetto piccolo modello 12,  
da indossare al collo, con grafica  
personalizzata della manifestazione.**

NECK PENNANT (PRO.COL12):  
Small pennant model 12,  
to wear around the neck with the  
event's customized graphic.

FANION DE COU (PRO.COL12):  
Petit fanion modèle 12,  
à porter autour du cou, avec des graphiques  
personnalisés de l'événement.

WIMPEL HALS (PRO.COL12):  
Kleines wimpelmodell 12,  
um den hals zu tragen, mit personalisierten  
grafiken der veranstaltung.

## PRO.COL12



- **Forme** ..... pag. 68-69  
Shapes  
Formes  
Formen
- **Misura e personalizzazione** ..... pag. 70  
Size and Customization  
Mesure et personnalisation  
Messung und Anpassung
- **Rifiniture** ..... pag. 71  
Finishings  
Finitions  
Bearbeitungen
- **Accessori** ..... pag. 72-73  
Accessories  
Accessoires  
Zubehör

# Lo STENDARDO

THE BANNER    L'ÉTENDARD    DAS BANNER



# 1) SCEGLI LA FORMA tra quelle riprodotte

CHOOSE THE SHAPE among those below.  
CHOISISSEZ LA FORME parmi celles figurant ci-dessous  
WÄHLEN SIE DIE FORM unter denen hier erscheint.

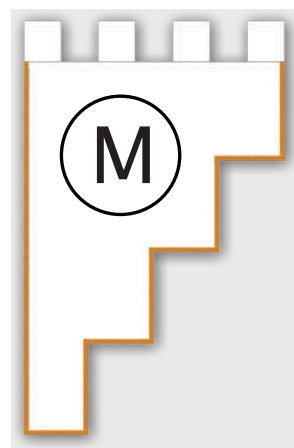
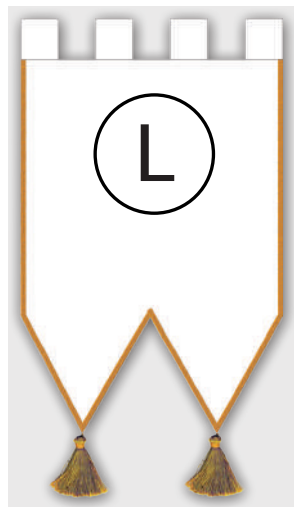
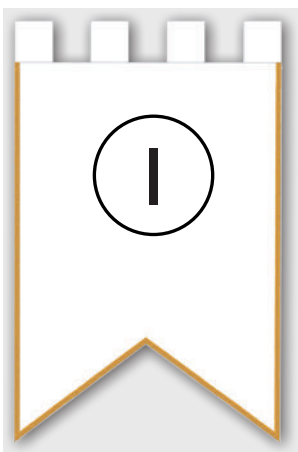
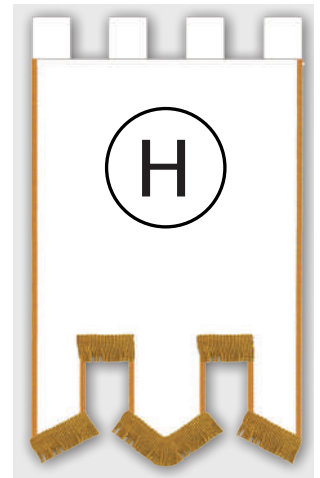
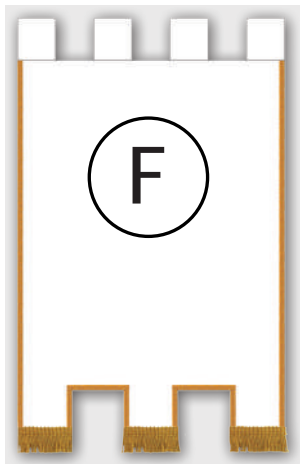
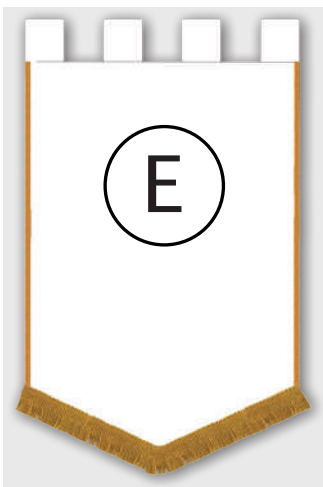
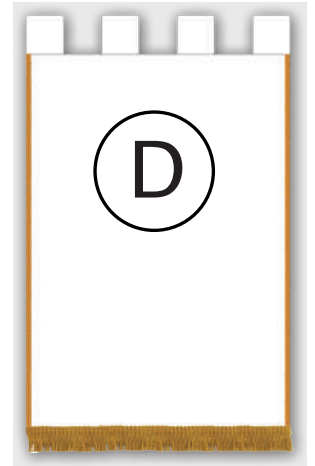
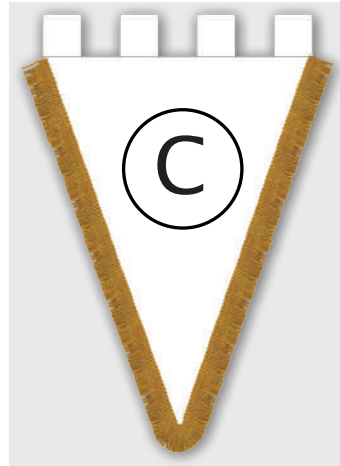
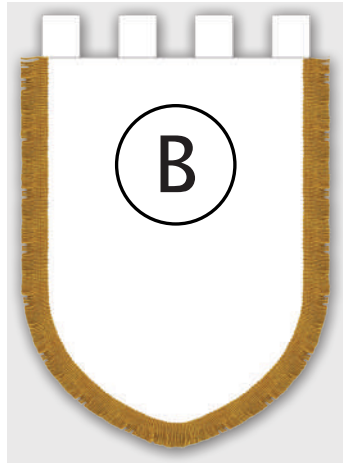
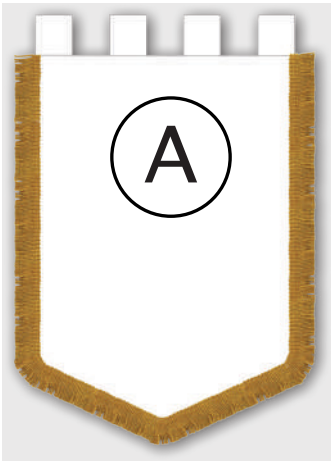

- A - PENTAGONALE**  
con frangia tripolino cm 5
- C - TRIANGOLARE**  
con frangia tripolino cm 5
- E - PENTAGONALE passamaneria/frangia**  
con frangia tripolino cm 5 e passamaneria cm 1
- G - MERLATO TRICOLORE**  
con passamaneria cm 1
- I - CODA SEMPLICE**  
con passamaneria cm 1
- M - STORICO**  
con passamaneria cm 1
- B - SCUDO**  
con frangia tripolino cm 5
- D - RETTANGOLARE**  
con frangia tripolino cm 5 e passamaneria cm 1
- F - MERLATO SEMPLICE**  
con frangia tripolino cm 5 e passamaneria cm 1
- H - MERLATO LUSO**  
con frangia tripolino cm 5 e passamaneria cm 1
- L - CODA CON FIOCCO**  
con passamaneria cm 1 e fiocco cm 12



**E' disponibile il kit completo degli accessori per gli alpini:  
ASTA (cm 180) - PUNTALE AQUILA - BORSONE - CINTURONE REGGI ASTA**

The complete kit of Alpine accessories is available: ROD (180 cm) - EAGLE TOE - BAG - RODBELT

Le kit complet d'accessoires pour les alpins est disponible: manche (180 cm) - POINTE AIGLE - SAC - CEINTURE PORTE MANCHE

Verfügbar das komplette Set an Zubehör für alpin: AUCTION (180 cm) - TOE AQUILA - BAG - BELT REGGI AUCTION

- A** : PENTAGONAL with fringe Tripoli cm 5  
: PENTAGONAL avec une frange Tripoli cm 5  
: PENTAGONAL mit Fransen Tripolis cm 5
- C** : TRIANGULAR with fringe Tripoli cm 5  
: TRIANGULAIRE avec une frange Tripoli cm 5  
: TRIANGULAR mit Fransen Tripolis cm 5
- E** : PENTAGONAL Tripoli fringes cm 5 and cm 1 trimmings  
: PENTAGONAL franges Tripoli cm 5 et cm 1 passementerie  
: PENTAGONAL Fransen Tripolis cm 5 und cm 1 Posament
- G** : CRENELLATED TRICOLORE with trimming cm 1  
: TRICOLORE CRÉNELÉ avec passementerie cm 1  
: ZINNEN TRICOLORE mit Besatz cm 1
- I** : TAIL SIMPLE with trimming cm 1  
: BOUT SIMPLE avec passementerie cm 1  
: CODA SIMPLE mit cm 1 Posament
- M** : HISTORICAL with trimming cm 1  
: HISTORIQUE avec passementerie cm 1  
: HISTORISCHE mit Posament cm 1
- O** : THE ALPINE banner  
: La bannière de l'ALPIN  
: Die ALPINE banner
- B** : SHIELD with fringe Tripoli cm 5  
: BOUCLIER avec une frange Tripoli cm 5  
: SCHILD mit Fransen Tripolis cm 5
- D** : RECTANGULAR with fringe Tripoli cm 5 and cm 1 trimmings  
: RECTANGULAIRE avec frange Tripoli cm 5 et cm 1 passementerie  
: RECTANGULAR mit Fransen Tripolis cm 5 und cm 1 Posament
- F** : CRENELLATED SIMPLE fringes Tripoli cm 5 and cm 1 trimmings  
: SIMPLE CRÉNELÉ franges Tripoli cm 5 et cm 1 passementerie INNEN  
: SIMPLE Fransen Tripolis cm 5 und cm 1 Posament
- H** : LUXURY CRENELLATED with fringe Tripoli cm 5 and cm 1 trimmings  
: LUXE CRÉNELÉ avec frange Tripoli cm 5 et cm 1 passementerie  
: LUXURY ZINNEN mit Fransen Tripoli umkämpfte cm 5 und cm 1 Posament
- L** : TAIL WITH TASSEL with trimming cm 1 and cm 12 tassel  
: BOUT AVEC POMPON avec passementerie cm 1 et cm 12 pompon  
: CODA BOW mit Posament cm 1 und cm 12 Bogen
- N** : THE ALPINE group's pennant  
: Fanion de groupe ALPIN  
: Die ALPINE Gruppe Wimpel

MADE IN ITALY



## 2) SCEGLI LA MISURA

CHOOSE THE SIZE  
CHOISISSEZ LA MESURE  
WÄHLEN SIE DIE MESS

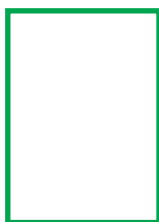

cm 50x70

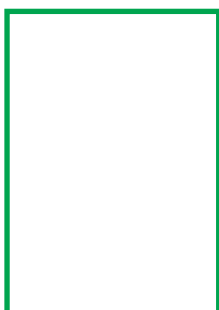

cm 70x100

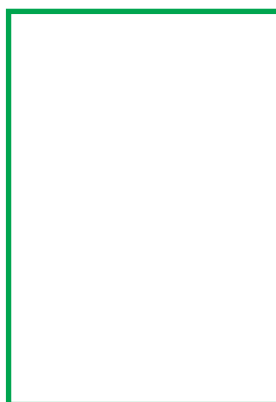

cm 90x130

## 3) SCEGLI LA TIPOLOGIA DI PERSONALIZZAZIONE

CHOOSE THE TYPE OF CUSTOMIZATION  
CHOISISSEZ LE TYPE DE PERSONNALISATION  
WÄHLEN SIE DIE ART DER ANPASSUNG

### RICAMO

EMBROIDERY  
BRODERIE  
STICKEREI



#### MATERIALE DISPONIBILE: raso turco o seta bemberg

MATERIAL AVAILABLE: turkish satin / bemberg silk  
MATÉRIEL DISPONIBLE: satin turc / soie bemberg  
MATERIAL ZUR VERFÜGUNG: Satin türkisch / Seide Bemberg

### STAMPA DIGITALE

DIGITAL PRINTING  
IMPRESSION NUMERIQUE  
DIGITALDRUCK



#### MATERIALE DISPONIBILE: raso turco

MATERIAL AVAILABLE: turkish satin  
MATÉRIEL DISPONIBLE: satin turc  
MATERIAL ZUR VERFÜGUNG: Satin türkisch

#### Puoi personalizzare il tuo standardo:

- a) SOLO FRONTE
- b) FRONTE UGUALE AL RETRO
- c) FRONTE DIVERSO DAL RETRO

You can customize your banner:

- a) FRONT ONLY
- b) FRONT EQUAL TO BACK
- c) FRONT DIFFERENT FROM BACK

Vous pouvez personnaliser

- a) SEULEMENT RECTO
- b) RECTO IDENTIQUE VERSO
- c) RECTO DIFFERENT DU VERSO

Sie können Ihr Banner an:

- a) NUR FRONT
- b) GLEICH VOR ZURÜCK
- c) FRONT ALS DIE RÜCKSEITE

## 4) SCEGLI IL COLORE delle varie rifiniture

CHOOSE THE finishings' COLOR  
 CHOISISSEZ LA COULEUR des différentes finitions  
 WÄHLEN SIE DIE FARBE der verschiedenen Ausführungen

### FRANGIA tripolino tagliata (altezza cm 5)

FRINGE tripolino cut (height cm 5)  
 FRANGE tripolino coupé (hauteur cm 5)  
 FRANSE tripolino schnitt (höhe cm 5)



**ORO LUREX**  
 gold lurex - or lurex  
 gold lurex



**ARGENTO LUREX**  
 silver lurex - argent lurex  
 silber lurex

### PASSAMANERIA (altezza cm 1)

TRIMMINGS (height cm 1)  
 PASSEMENTERIE (hauteur cm 1)  
 ZUTATEN (höhe cm 1)



**ORO LUREX**  
 gold lurex - or lurex  
 gold lurex



**ARGENTO LUREX**  
 silver lurex - argent lurex  
 silber lurex

### FIOCO (altezza cm 12)

TASSEL (height cm 12)  
 POMPON (hauteur cm 12)  
 SCHLEIFE (höhe cm 12)



**ORO LUREX**  
 gold lurex - or lurex  
 gold lurex



**ARGENTO LUREX**  
 silver lurex - argent lurex  
 silber lurex

### CORDONIERA (Ø cm 1) lunghezza disponibile cm 150 / cm 240

lengths available cm 150 / cm 240  
 longueurs disponibles cm 150 / cm 240  
 längen erhältlich cm 150 / cm 240



**ORO LUREX**  
 gold lurex - or lurex  
 gold lurex



**ARGENTO LUREX**  
 silver lurex - argent lurex  
 silber lurex



## 5) VISIONA E SCEGLI tra i vari accessori

VIEW AND CHOOSE among the different accessories  
 REGARDEZ ET CHOISISSEZ parmi les différents accessoires  
 ANSICHT UND WÄHLEN Sie zwischen den verschiedenen Zubehör

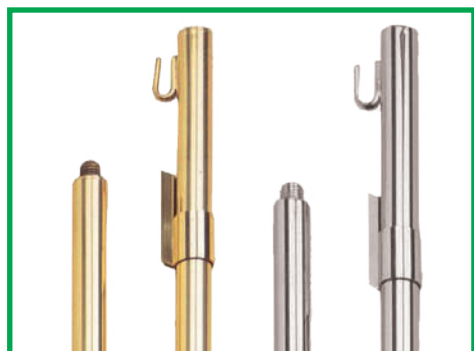

**ASTA ottone dorato / cromato**  
(Ø cm 22)

ROD golden/ chrome brass  
 TIGE laitondoré/ chromé  
 AUKTION goldenen Messing  
 Chrom

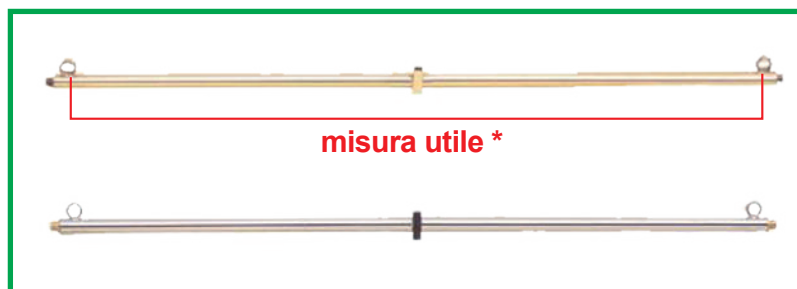

**TRAVERSA ottone dorato / cromato**  
(Ø cm 22)

CROSSBAR golden/ chrome brass  
 BARRE TRANSVERSALE laiton doré / chrome  
 QUER goldenen Messing / Chrom

Consulta la tabella per scegliere  
 la misura giusta per i tuoi accessori

See the table to choose the right size for your accessories  
 Voir le tableau pour choisir la bonne taille pour vos accessoires  
 In der Tabelle, die richtige Größe für Ihr Zubehör wählen

MISURA gonfalone	ASTA	TRAVERSA
banner's measures mesures bannière messen banner	rod tige auktion	crossbar barre Querträger
50x70	cm 180	cm 55
70x100	cm 210	cm 75
90x130	cm 225	cm 95

**\* Per "misura utile" si intende da anello ad anello**  
 The "relevantmeasure" means ringto ring  
 "La mesureutile" signifie du maillonau maillonDie  
 entsprechendMaßnahmesoll denRingRing



**FASCIA TRICOLORE in raso turco**  
(cm 130)

TRICOLOR BAND in turkish satin  
 BANDE TRICOLORE en satin turc  
 TRIKOLORE in turkischem satin

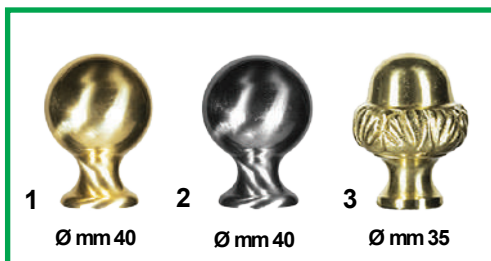

**POMOLI ottone dorato/cromato**

KNOBS golden/ chrome brass  
 POMMEAUX laitondoré/ chrome  
 KNOBS goldenenMessing/ Chrom

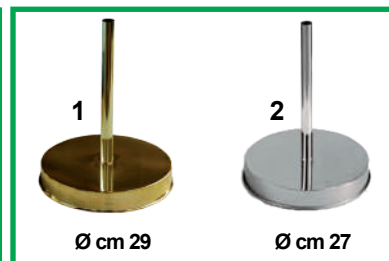

**BASE ottone dorato / acciaio inox**

BASE golden brass / stainless steel  
 BASE laiton doré / inox  
 BASE goldenen Messing / Edelstahl

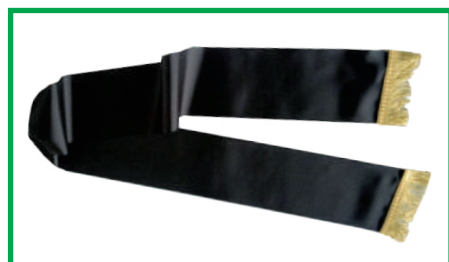

**FASCIA LUTTO in raso turco**  
(cm 130)

MOURNING BAND in turkish satin  
 BANDE DE DEUIL en satin turc  
 TRAUERBAND in turkischem satin



**CINTURONE reggi asta**

rod BELT  
 CEINTURE porte tige  
 BELT Kleiderstange



**BORSA porta standardo**  
(cm 100 x 15 x 6)  
(cm 125 x 25 x 6)

BAG  
 SAC

# LANCE ed EMBLEMI (in ottone)

LANCE and EMBLEMS (brass)  
LANCE et emblèmes (laiton)  
LANZE und Embleme (Messing)



**Generica grande oro (art.171/G)**  
Generic large gold  
Générique grande, dorée  
Generisches großes gold



**Generica grande cromata (art.171/GC)**  
Generic large chrome  
Générique grande, chromée  
Generisches großes chrom



**Generica piccola oro (art.171)**  
Generic small gold - Générique petite dorée - Generisches klein gold



**Generica piccola cromata (art.171/C)**  
Generic small chrome  
Générique petite, chromée  
Generisches klein chrom

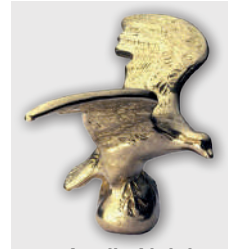

**Aquila Alpini (art.174/ALP)**  
Alpine eagle - Aigle Alpin - Alpine Adler



**Ancora Marina (art.186/MA)**  
Anchor Marine - Ancre Marine  
Anker Marine



**Fiamma Carabinieri (art.173)**  
Flame Carabiniers  
Flamme carabinieri  
Flamme Karabinieri



**Polizia (art.186/PO)**  
Police - Police  
Polizei



**Guardia di Finanza (art.186/FI)**  
Customs corps - Garde des Finances  
Garde des Finances



**Vigili del fuoco (art.186/VF)**  
Firefighters - Les pompiers  
Feuerwehr



**Paracadutisti (art.186/PA)**  
Paratroopers - Parachutistes  
Fallschirmjäger



**Combattenti (art.186/CO)**  
Fighters - Combattants  
Kämpfer



**Croce Rossa (art.186/CR)**  
Red Cross - Croix Rouge  
Rotes Kreuz



**Croce Verde (art.186/CV)**  
Green Cross - Croix verte  
Grüne Kreuz



**Statuto Militare (art.186/STAT)**  
Statute Military - Statut militaire  
Statut der Militär



**Emblema Avis (art.181)**  
Emblem Avis - Emblème Avis  
Emblem Avis

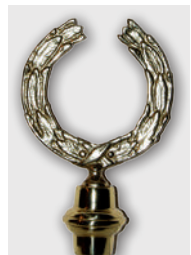

**Corona Alloro (art.172)**  
Laurel wreath - Couronne de laurier - Crown Alloro



**Emblema Mariano (art.186/EM)**  
Emblem Marian - Emblème Marian  
Emblem Marian



**Emblema Musicale (art.186)**  
Emblem Musical  
Emblème Musical  
Emblem Musical



**Lancia comuni incisa (art.177)**  
Lance common engraved  
Lance des communes gravée  
Lancia gemeinsamen graviert



**Stella ANPI (art.186/S)**  
Star ANPI - Etoile ANPI  
Stern ANPI



**Europa (art.175)**  
Europe - Europe  
Europa



**Emblema Rep.Italiana (art.170)**  
Emblem Rep. Italian  
Emblème Rep. Italienne  
Emblem Rep. Italienisch



**Croce (art.186/CF)**  
Cross - Croix  
Kreuz



**Emblema Bersaglieri (art.185)**  
Emblem Sharpshooters  
Emblème Tireurs d'élite  
Emblem Scharfschützen

**Abbiamo disponibilità di tanti altri accessori; per richieste particolari vi invitiamo a contattarci tramite e-mail o via telefono.**

There are many other accessories; for any special requests, please contact us by e-mail or telephone.

Il existe de nombreux autres accessoires; pour une autre demande, contactez-nous par e-mail ou par téléphone.

Es gibt viele andere Teile; Besondere Anfragen kontaktieren Sie uns bitte per E-Mail oder Telefon.

# LA BANDIERA

THE  
FLAG

LE  
DRAPEAU

DAS  
FLAGGE

- **Istituzionali** ..... pag. 75  
Institutional  
Institutionnel  
Institutionell
- **Personalizzate** ..... pag. 76  
Customize  
Personnaliser  
Anpassen
- **Bandierine e festoni** ..... pag. 77  
Flags and festoons  
Drapeaux et banderoles  
Fahnen und Girlanden



# BANDIERE ISTITUZIONALI

## di Nazioni, Regioni, Province, Città, Enti e Associazioni

Institutional flags of Nations, Regions, Provinces, Cities, Organizations and Associations  
 Drapeaux institutionnels nations, régions, provinces, villes, organisations  
 Institutionelle Fahnen Nationen, Regionen, Provinzen, Städte, Organisationen



### 1) Misure disponibili

Size available  
 Mesures disponibles  
 Maßnahmen verfügbar

cm: 15x21 / 20x30 / 50x70 / 70x100 / 100x150 / 150x220  
 200x300 / 250x375 / 275x415 / 300x450 / 400x600

### 2) Materiale disponibile

Material available  
 Matériel disponible  
 Material verfügbar

#### Poliestere Nautico (da esterno)

Nautical Polyester (outdoor)  
 Polyester nautique (en plein air)  
 Nautical Polyester (im Freien)

#### Poliestere Leggero (da interno)

Polyester Light (indoor)  
 Polyester légère (intérieur)  
 Polyester-Leicht (innen)

### 3) tipologie di confezionamento

Types of packaging  
 Types de confectionnement  
 Verpackungsarten

- A Double perimetric hem , reinforced strap and rope fastening on the side.  
 Double ourlet périmétral, sangle de renforcement corde de fixation sur le côté.  
 Doppel hem Umfang, Stahlband und Seilbefestigung an der Seite.
- B Double perimetric hem, reinforced strap and D-rings synthetic material.  
 Double ourlet périmétral, sangle de renforcement et anneaux en D en matière synthétique. Doppel hem Umfang, Stahlband und D-Ringe Kunststoff.
- C Double perimetric hem and synthetic snaps.  
 Double ourlet périmétral et mousquetons synthétiques.  
 Doppel hem Umfang, Stahlband und Snap Kunststoff.
- D Double perimetric hem, lateral strings.  
 Double ourlet périmétral, et lacets latéraux  
 Doppel hem Umfang, Seiten Saiten.
- E Double perimetric hem and sheath for rods.  
 Double ourlet périmétral et gaine pour les tiges.  
 Doppel hem Umfang Mantel zur Versteigerung.

Doppio orlo perimetrale, cintino di rinforzo e corda di fissaggio sul lato.

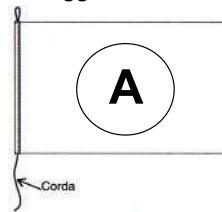

Doppio orlo perimetrale, cintino di rinforzo e anelli a D in materiale sintetico.

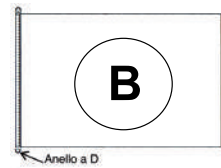

Doppio orlo perimetrale, moschettoni in materiale sintetico.

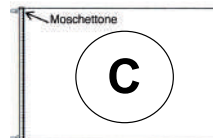

Doppio orlo perimetrale, fettucce laterali.

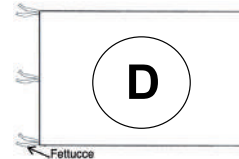

Doppio orlo perimetrale, guaina per aste.

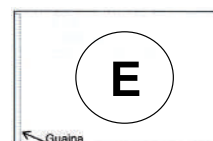

### 4) Possiamo rifornirvi di una vasta gamma di diversi accessori di supporto.

We can also provide a wide range of different accessories.  
 Nous pouvons aussi vous fournir un large éventail d'accessoires divers.  
 Auch können wir auf ein breites Spektrum von verschiedenen Accessoires Lager.

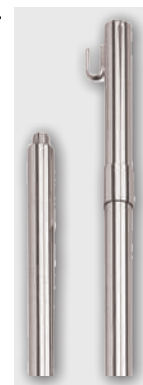
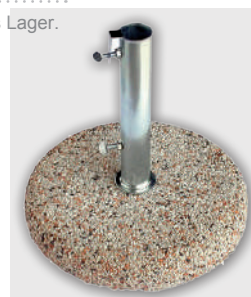

# BANDIERE PERSONALIZZATE

orizzontali / verticali / a goccia / a vela

personalized flags horizontal / vertical / drop / sail  
drapeaux personnalisés horizontaux/ verticaux / goutte / voile  
personalized Fahnen horizontal / vertical / Tropf / Segeln



## 1) Misure disponibili

Size available  
Mesures disponibles  
Maßnahmen verfügbar

cm: 15x21 / 20x30 / 50x70 / 70x100 / 100x150 / 150x220  
200x300 / 250x375 / 275x415 / 300x450 / 400x600

## 2) Materiale disponibile

Material available  
Matériel disponible  
Material verfügbar

### Poliestere Nautico (da esterno)

Nautical Polyester (outdoor)  
Polyester nautique (en plein air)  
Nautical Polyester (im Freien)

## 3) Stampa

Print  
Impression  
Drucken

### Digitale, coprenza 99%

Digital, opacity 99%  
Numérique, opacité de 99%  
Digital, Deckkraft 99%

## 4) Tipologie di confezionamento

Types of packaging  
Types de confectionnement  
Verpackungsarten

### Vedi pag. 75

See pag. 75  
Voir page 75  
Du Siehst pag. 75

## 5) Accessori di supporto

Support accessories  
Accessoires de soutien  
Support Zubehör

### Vedi pag. 75

See pag. 75  
Voir page 75  
Du Siehst pag. 75

## Modello A GOCCIA



**1) Misure**  
Sizes  
Mesures  
Maßnahmen

90x220  
90x250  
90x300  
90x400

## 2) Materiale

Material  
Matériel  
Material

**Poliestere Nautico**  
Nautical Polyester  
Polyester nautique  
Nautical Polyester

## 3) Stampa

Print  
Impression  
Drucken

**Digitale, coprenza 99%**  
Digital, opacity 99%  
Numérique, opacité de 99%  
Digital, Deckkraft 99%

## 4) Struttura

Structure  
Structure  
Struktur

### Alluminio

Aluminum  
Aluminium  
Aluminium

## Modello A VELA



## 1) Misure

Size  
Mesures  
Maßnahmen

70x230	90x320
70x300	90x415
90x280	90x510

## 2) Forme disponibili

Available shapes  
Formes disponibles  
Forms verfügbar



## 3) Materiale

Material  
Matériel  
Material

### Poliestere Nautico

Nautical Polyester  
Polyester nautique  
Nautical Polyester

## 4) Stampa

Print  
Impression  
Drucken

### Digitale, coprenza 99%

Digital, opacity 99%  
Numérique, opacité de 99%  
Digital, Deckkraft 99%

## 5) Struttura

Structure  
Structure  
Struktur

### Alluminio

Aluminum  
Aluminium  
Aluminium

### Disponibili svariati accessori adatti ad ogni tipo di necessità.

Several accessories are available for any need.

Plusieurs accessoires disponibles pour chaque type de besoin.

Diverses Zubehör für jede Art von Bedarf zur Verfügung.



# BANDIERINE e FESTONI

flags and festoons  
drapeaux et banderoles  
Fahnen und Girlanden



## Bandierine in polipropilene riciclabile al 100%, personalizzabili, con astina e puntalino.

Polypropylene flags are 100% recyclable, customizable, with rod and ferrule.

Drapeaux en polypropylène qui sont 100% recyclables, personnalisables, avec la tige et la virole.

Flaggen Polypropylen sind zu 100% recyclebar, kundengerechte, mit Stab und Hülse.

### Misure disponibili

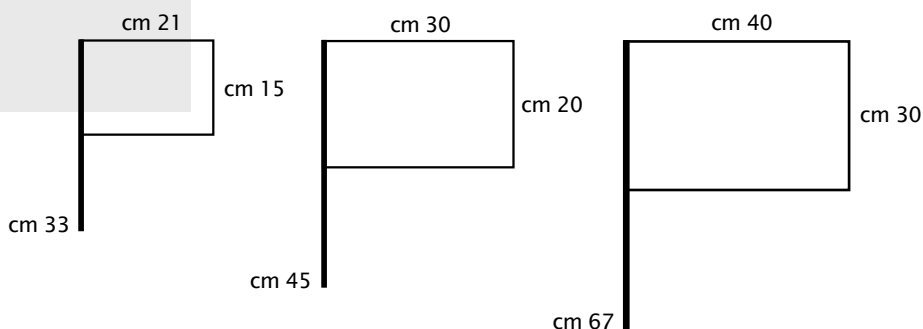

## Festoni in polietilene 160 micron, delle nazioni o personalizzati.

Polyethylene festoons 160 microns, of nations or customizable.

Banderoles en polyéthylène 160 microns, des nations ou personnalisables.

Girlanden Polyethylen 160 Mikron, anpassbar.



**Lunghezza:** metri 10  
**Composizione:** 20 bandierine cm 20x30  
**Distanza:** cm 20 l'una dall'altra



Length: 10 meters

Composition: 20 flags 20x30 cm

Distance: 20 cm from each other

Longueur: 10 mètres

Composition: 20 drapeaux 20x30 cm

Distance: 20 cm l'un de l'autre

Länge: 10 Meter

Zusammensetzung: 20 Fahnen 20x30 cm

Abstand: 20 cm voneinander

# Ci vantiamo di fornire prodotti di **ALTISSIMA QUALITÀ**, rigorosamente **MADE IN ITALY**

We are proud to provide HIGHEST QUALITY products, all MADE IN ITALY

Nous sommes fiers de fournir des produits de HAUTE QUALITE, tous FABRIQUES EN ITALIE

Wir sind stolz darauf, Produkte von HÖCHSTER QUALITÄT, die ALLE IN ITALIEN

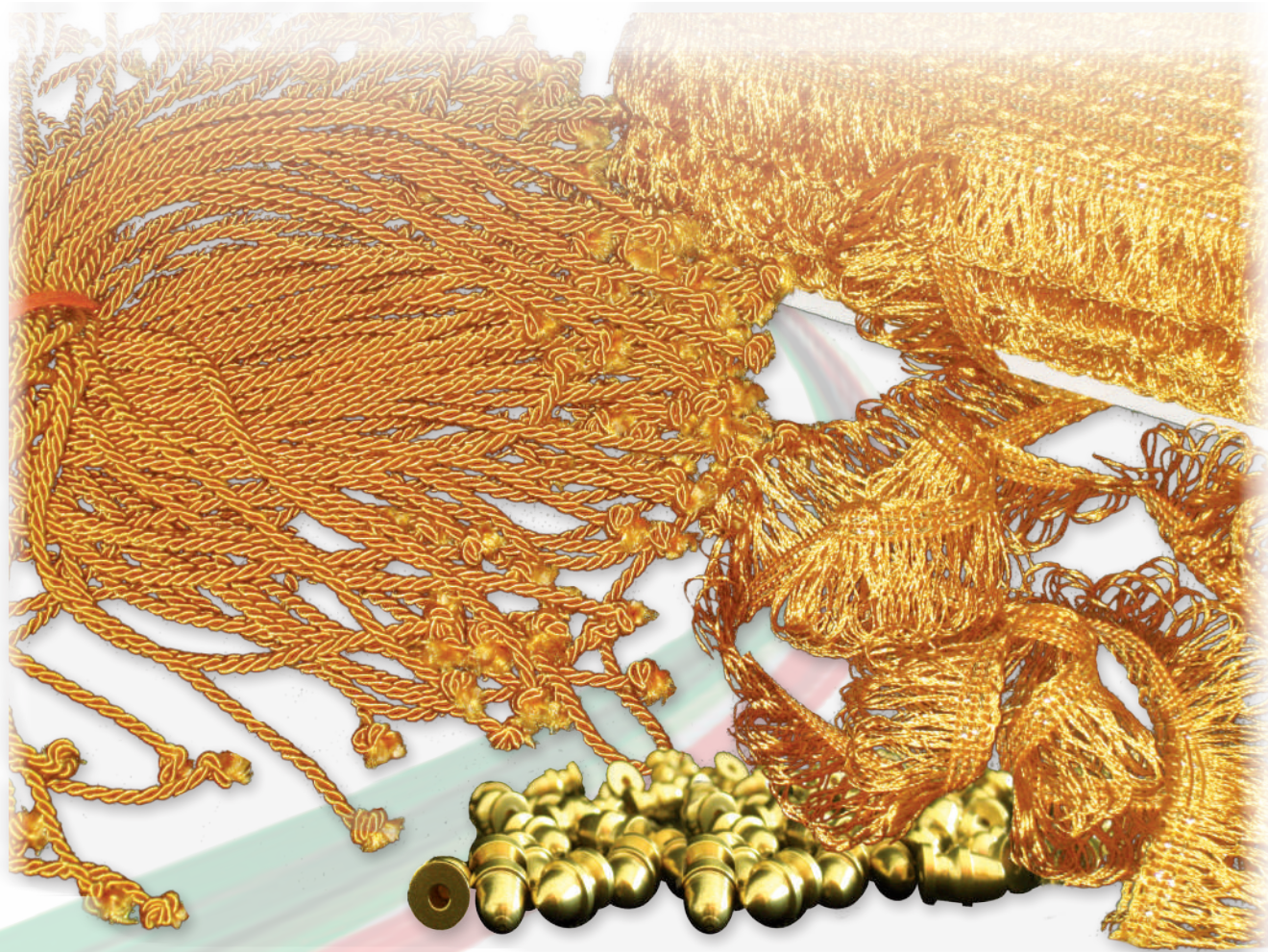

***“Un pianeta migliore è un sogno  
che inizia a realizzarsi  
quando ognuno di noi decide di migliorare se stesso.”***

**MAHATMA GANDHI**

“A better planet is a dream which starts  
to become true when everyone decides  
to improve”

... AND OUR MISSION IS TO  
CONTINUE TO IMPROVE TO US...

“Un planète meilleur est un rêve qui  
commence se réaliser quand chacun  
de nous décide de s'améliorer”

...ET NOTRE MISSION EST  
CONTINUER À NOUS AMÉLIORER...

“Planet ist ein Traum dass es beginnt, sich zu  
verwirklichen wenn jedes von uns wenn gleich  
entscheidet, zu verbessern”

... IST UNSERE MISSION UND FORTZUSETZEN  
UNS ZU VERBESSERN...

**...e la nostra missione è continuare a migliorarci...**

**MADE IN ITALY**



MADE IN ITALY